

PSRIP
GRADE 1
TERM 3 2021

FIRST ADDITIONAL
LANGUAGE
ENGLISH

RESOURCE PACK

WEEKS

1 & 2

All around

town

ck

sick

kick

pack

sack

sock

mock

taxi

town

street

bus stop

school

clinic

drive

driver

drove

hurry

petrol

full

empty

walk

by foot

path

sidewalk

drives

taxi

around

all

b

bit

bat

bed

back

sob

mob

safe

safer

unsafe

home

alone

shop

shebeen

warn

warning

passage

between

dark

night

light

day

worried

fast

faster

run

friend

sister

together

petrol station

passenger

important

I like to

go to . . .

I feel

safe . . .

WEEKS

3&4

**Working
together**

h

hit

hat

hot

hop

hen

hack

work

help

class

giant

pull

stuck

ground

dirty

sweaty

call

family

strong

clever

right

wrong

team

here

please

dog

u

sun

bun

gun

bug

hug

dug

mess

messy

messier

clean

job

problem

scrub

carpet

fix

broken

paint

wall

pile

papers

box

recycle

gather

idea

group

queue
↓

they

work

pull

beetroot

classmate

frustrated

teamwork

I work

with . . .

My friends

and I . . .

WEEKS

5&6

All about

clothes

r

rat

rip

rag

rock

rub

red

clothing

blue

red

purple

wear

boots

orange

green

dress

pants

skirt

uniform

jersey

shirt

cold

warm

rain

puddle

wet

dry

up

down

in

T-shirt

choose

pink

white

dinosaur

car

plain

buy

disagree

argue

shopping

boy

girl

front

back

koki pen

draw

mirror

colourful

what

buy

two

shirts

f

fat

fit

fig

fed

fin

far

frustrated

I love to

wear . . .

I want to
buy . . . at the
clothing shop!

WEEKS

7&8

**Reading is
fun!**

book

fun

read

parents

page

turn

title

picture

words

gift

in love

dream

carry

this

book

ff

ruff

cuff

buff

huff

puff

comics

Bible

difficult

story

phone

app

download

bored

boring

search

exciting

aloud

share

silent

noise

data

free

language

airtime

read

wants

for

books

cover

story

title

author

comics

page number

character

interesting

newspaper

I like to

read with...

I want to
read a story
about . . .

WEEKS

9 & 10

Keeping our
bodies healthy
and safe

l

lip

lap

lot

lad

lick

lock

body

helmet

bike

bicycle

crash

broken

bone

rock

hurt

head

fall

protect

wash

seatbelt

sick

healthy

sleep

tired

awake

brain

wear

ride

||

ball

call

fall

pill

kill

hill

secret

tell

trust

brave

kiss

lips

hug

food

fruit

many

ignore

listen

feeling

shout

greet

high five

window

mother

father

feel

uncomfortable

vegetable

underneath

My body is
healthy when
I...

I trust . . .

WORD

FAMILIES

- ack

- ag

- all

- ar

- ed

- ick

- ill

- ob

- ock

- ub

- uff

- ug

- un

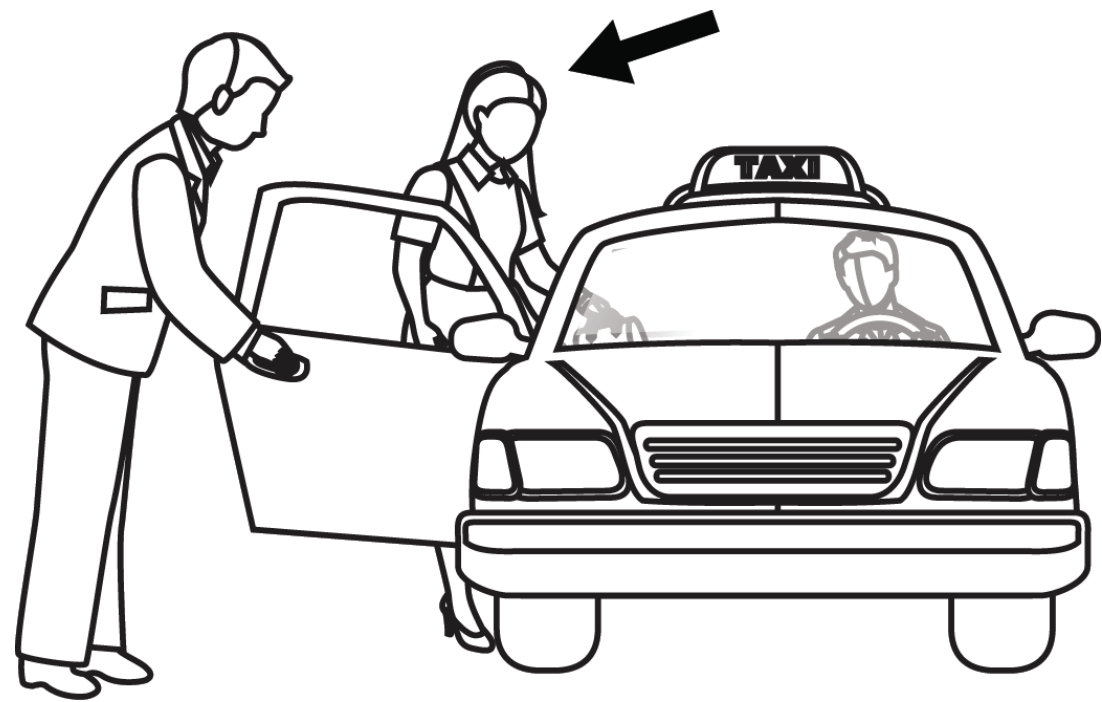

passenger

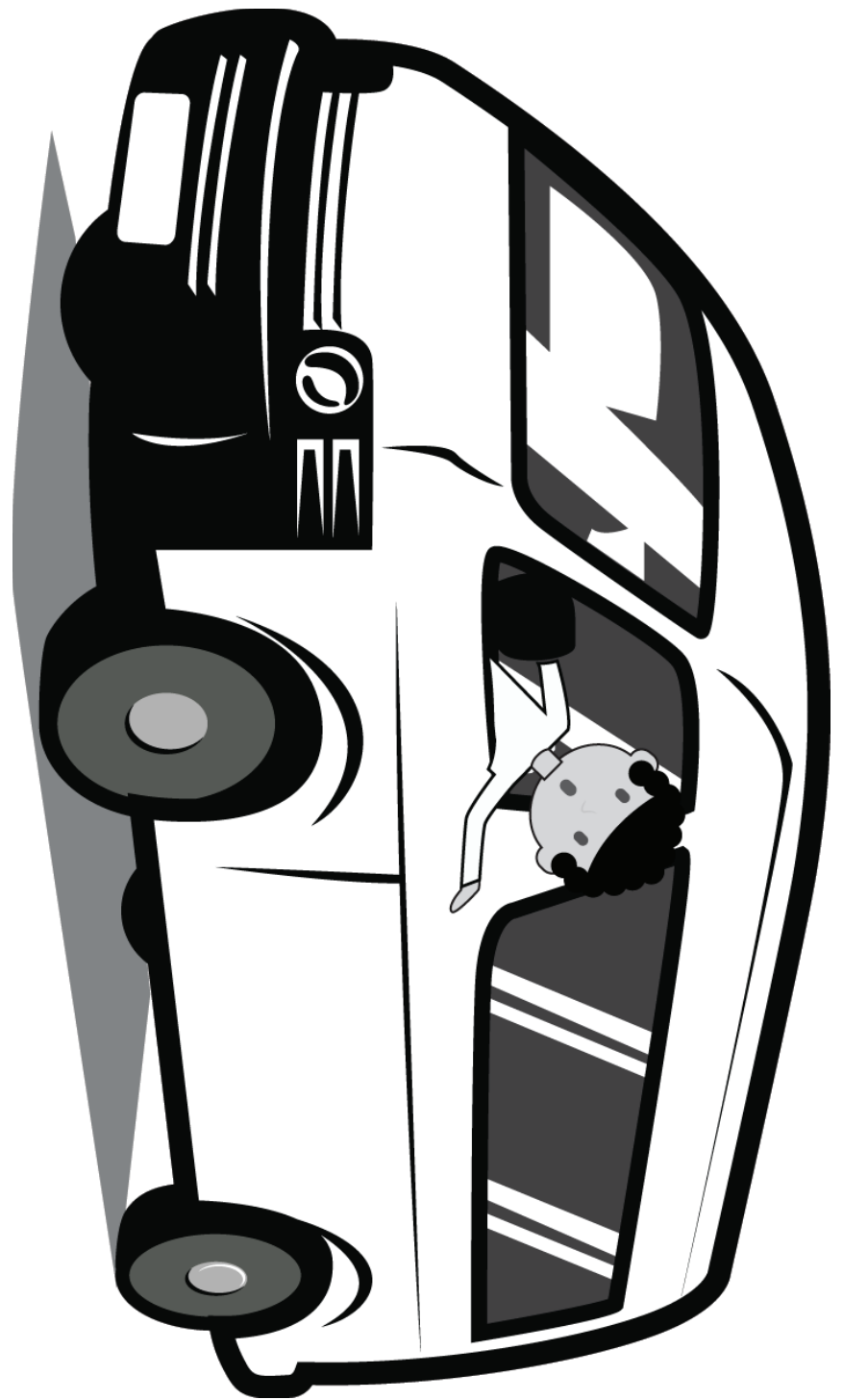

taxi

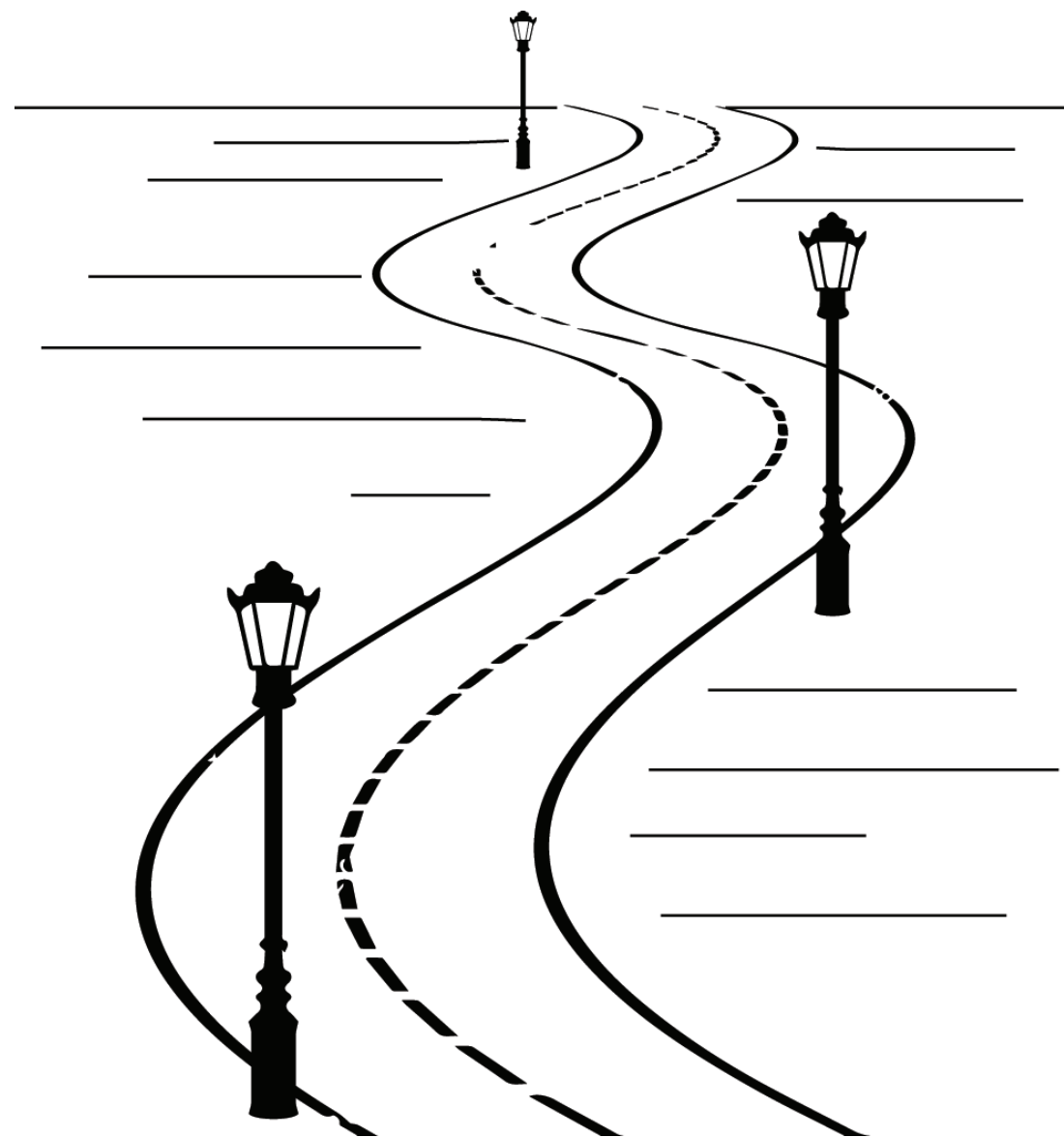

street

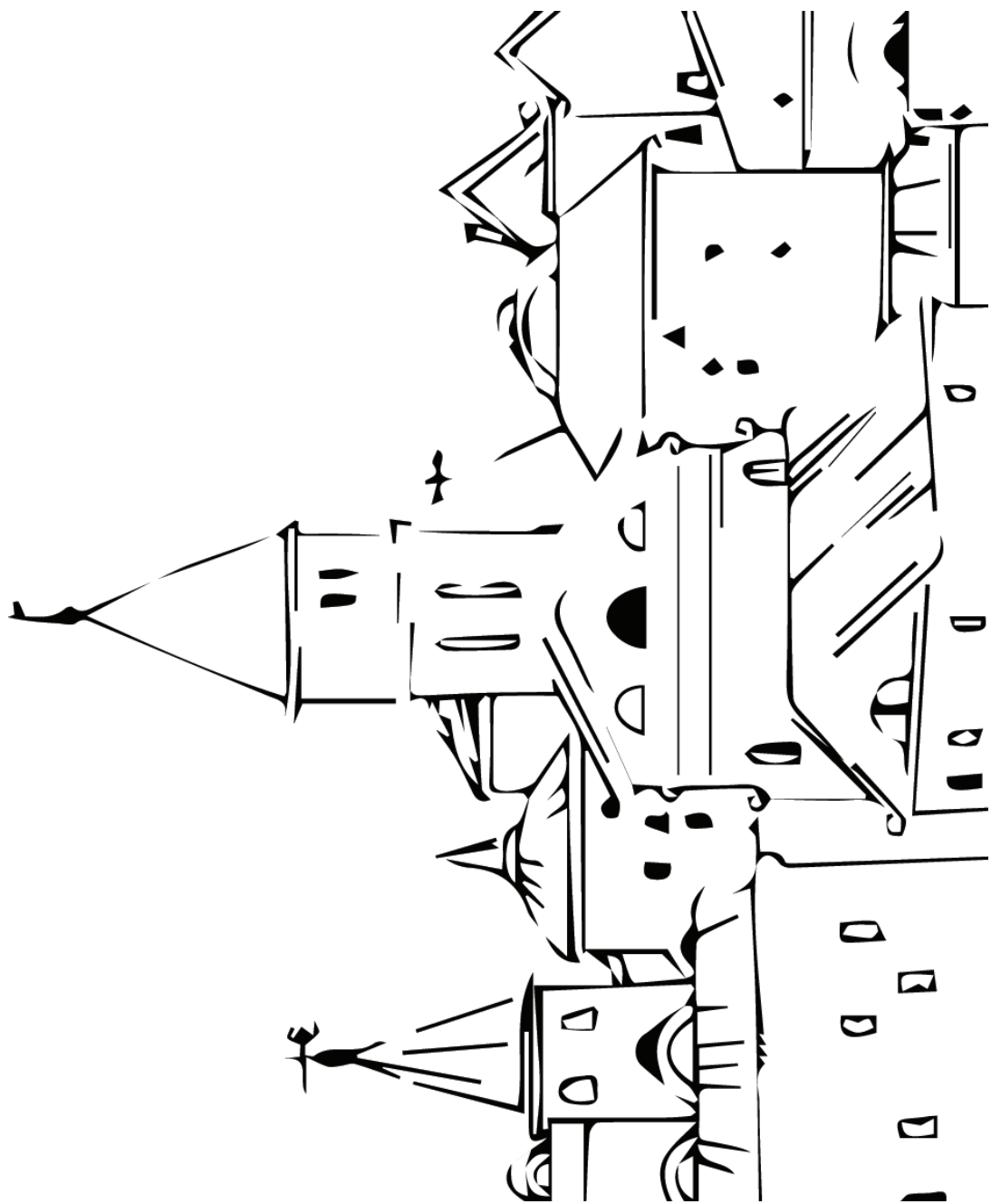

town



school

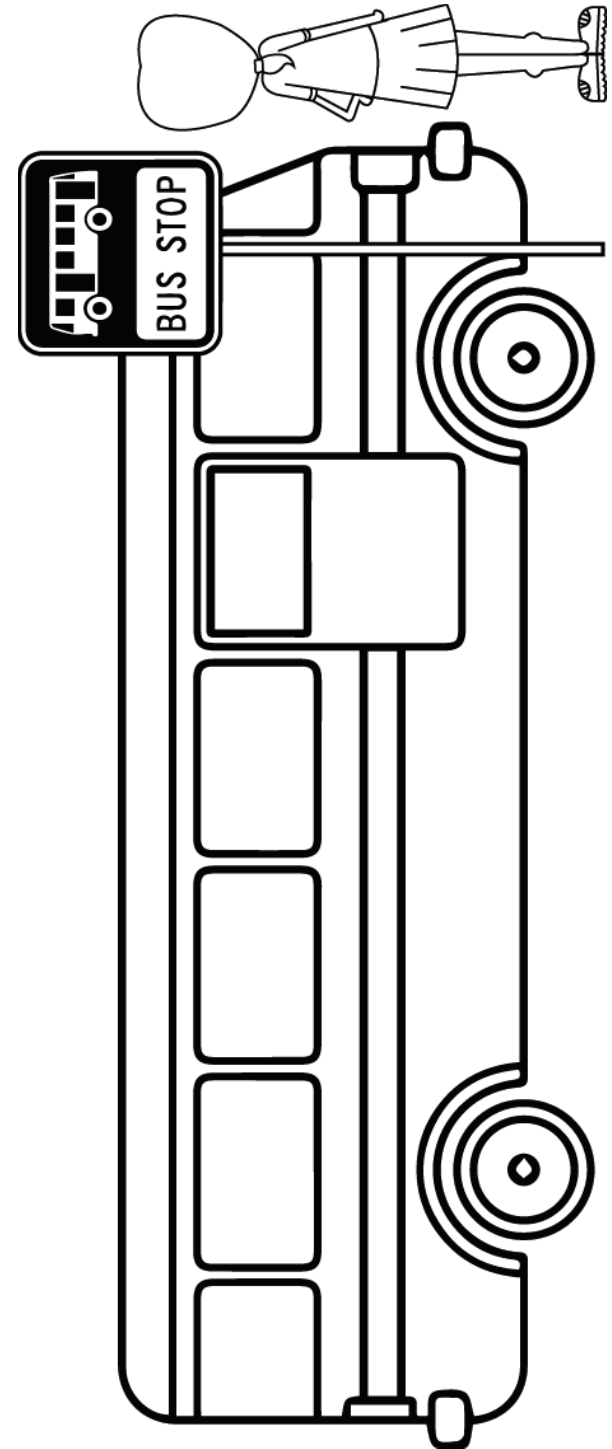

bus stop

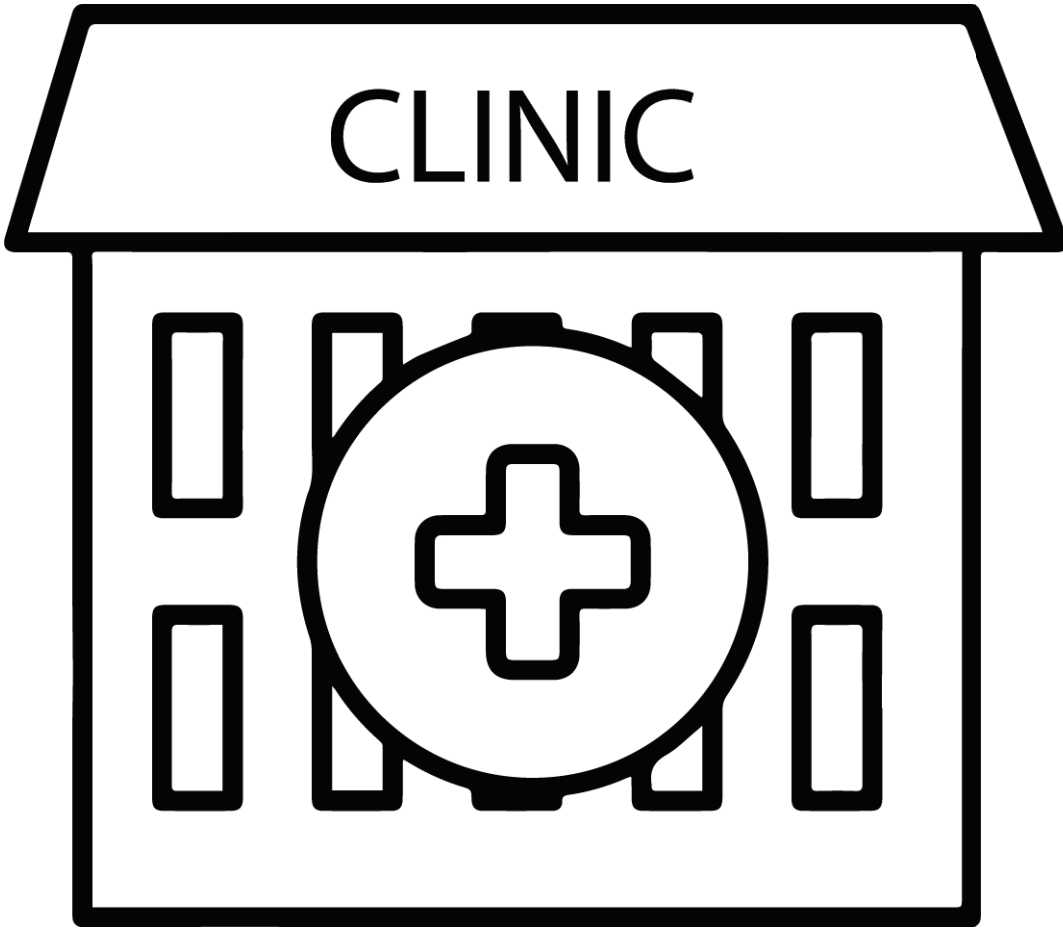

clinic

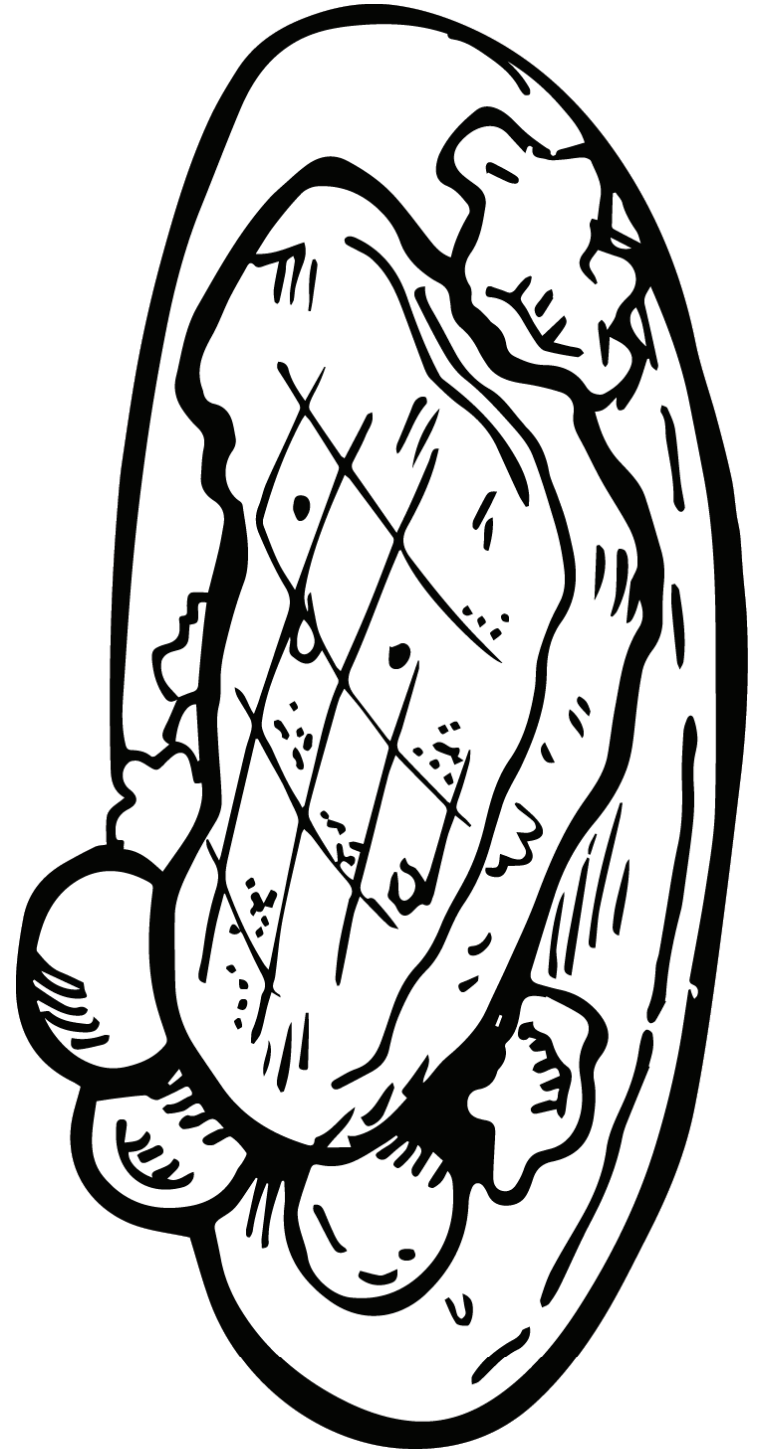

food

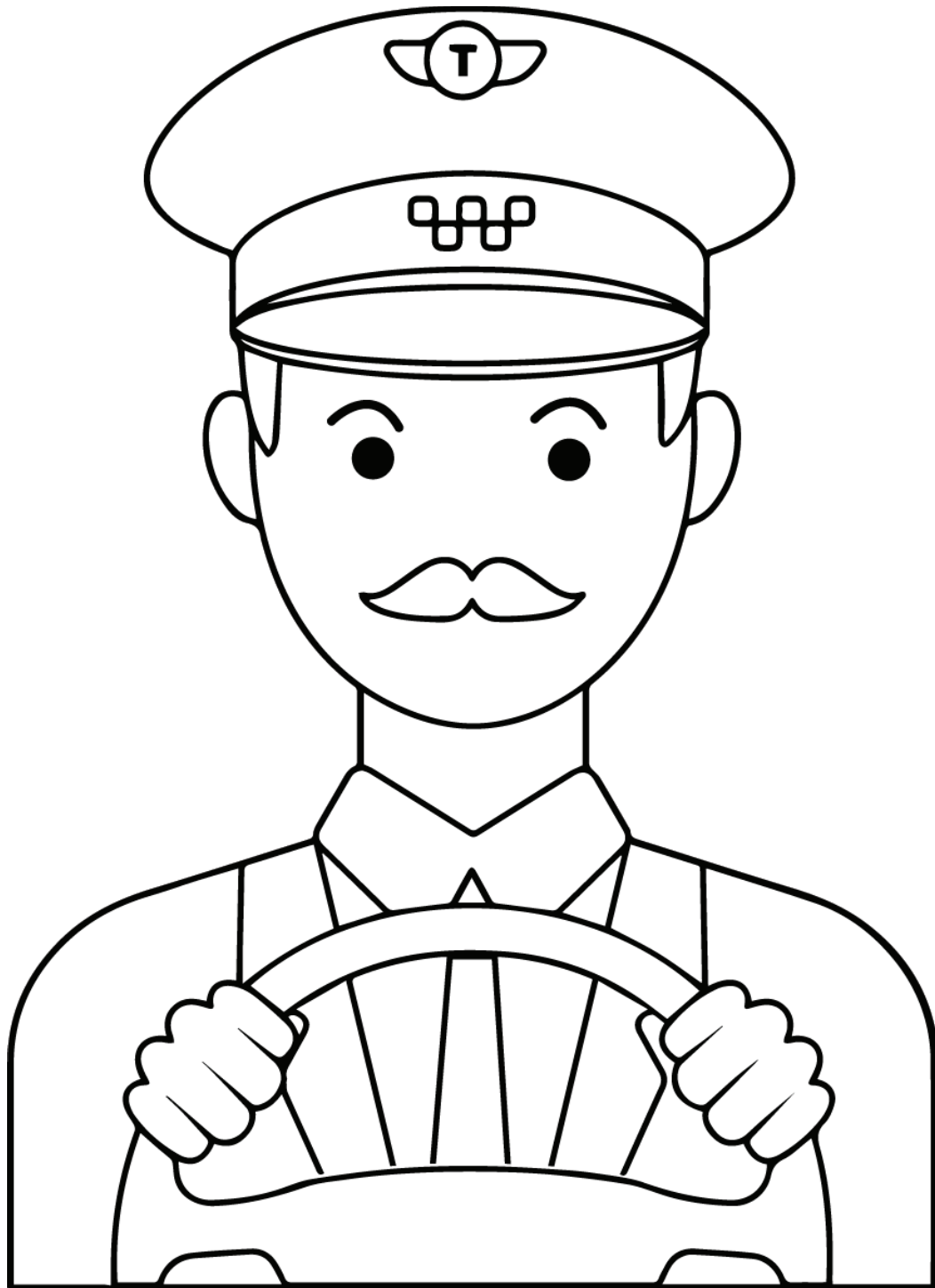

driver

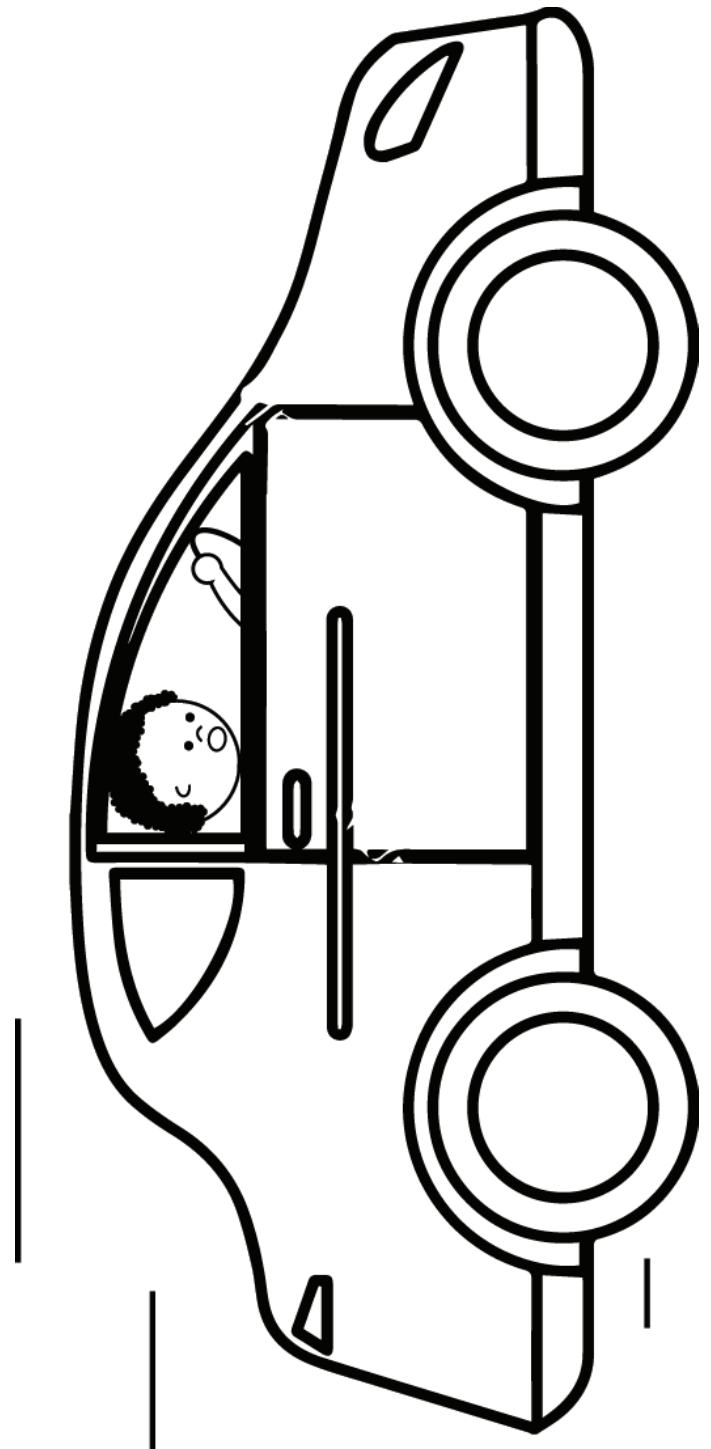

drive

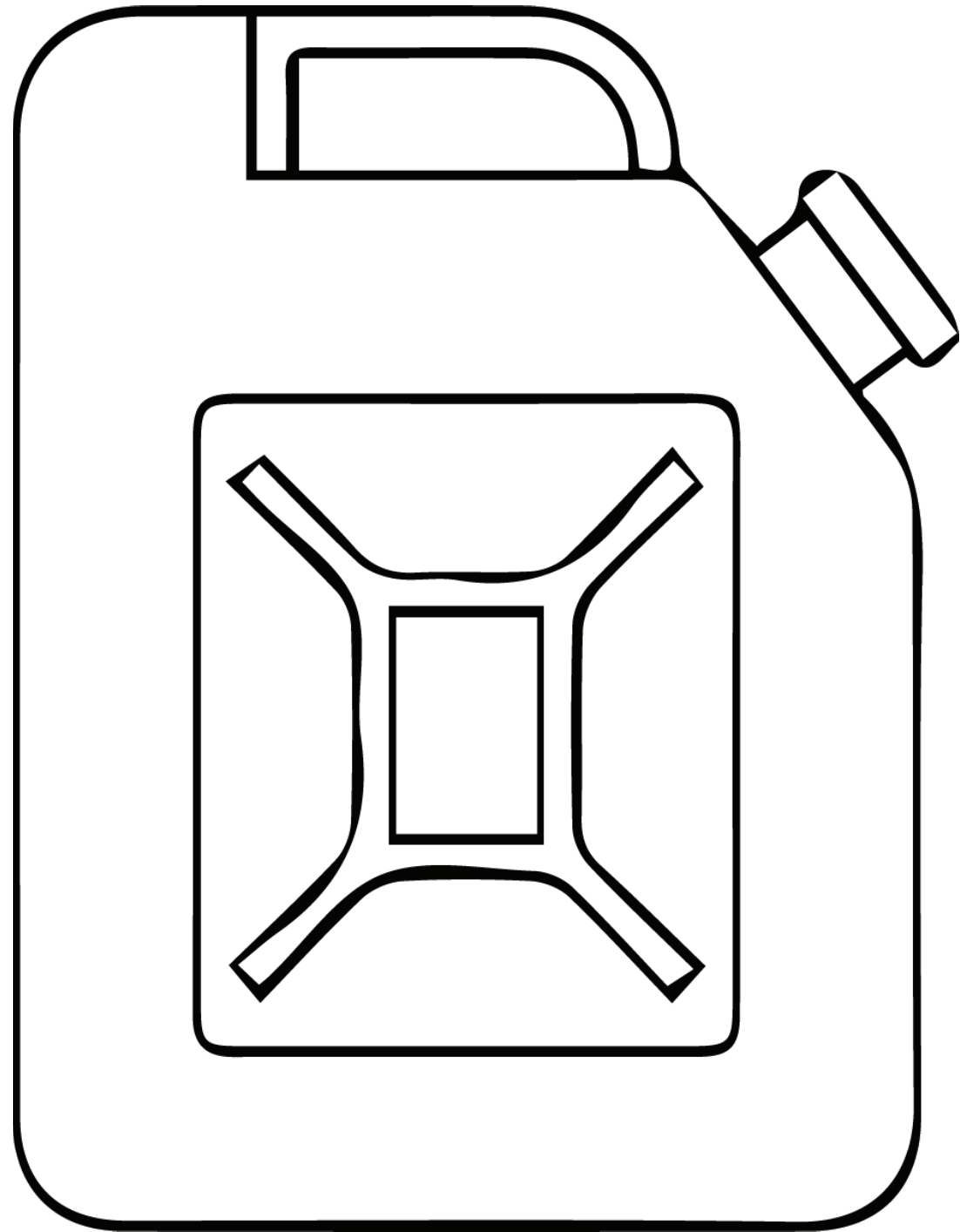

petrol

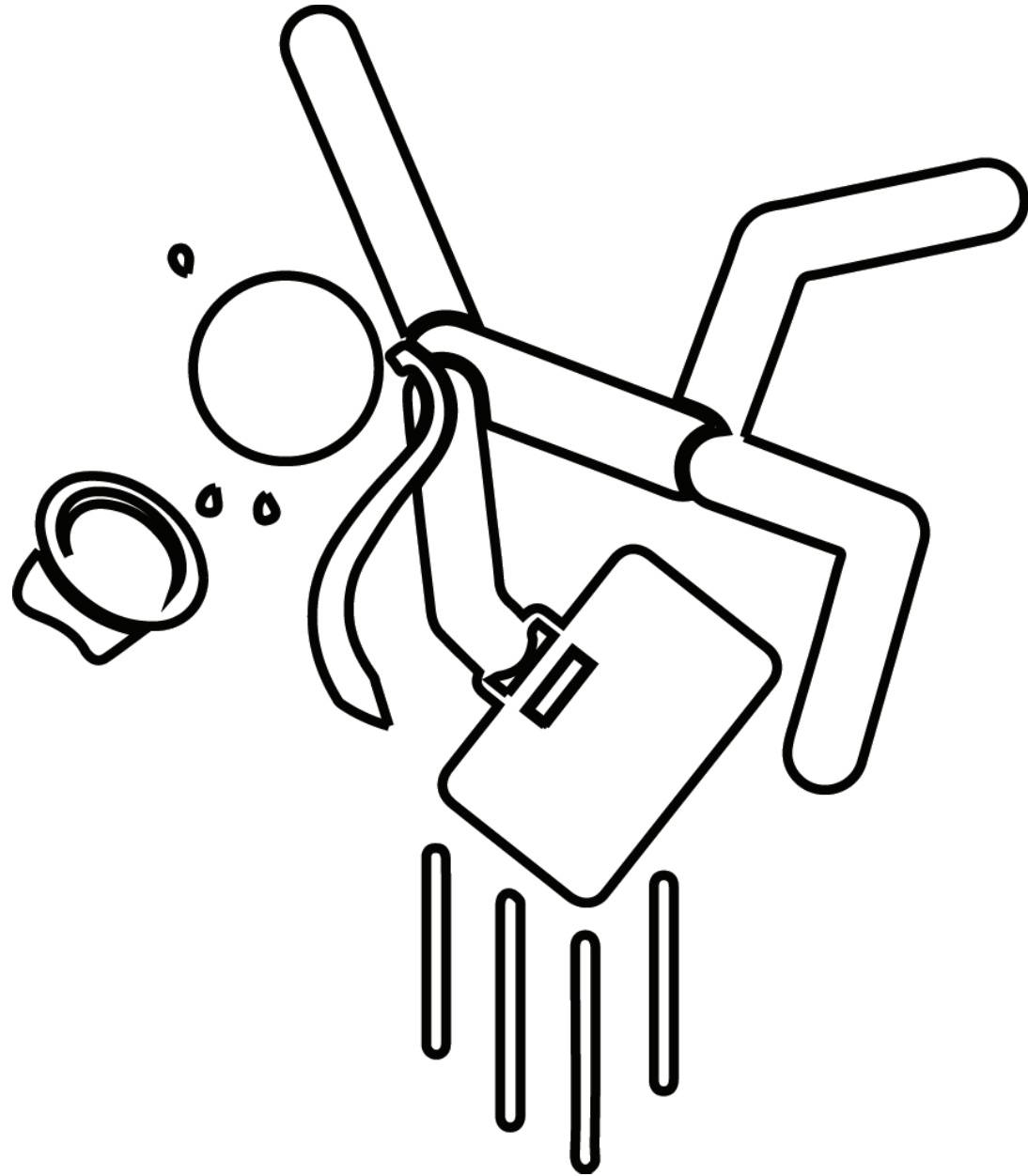

hurry

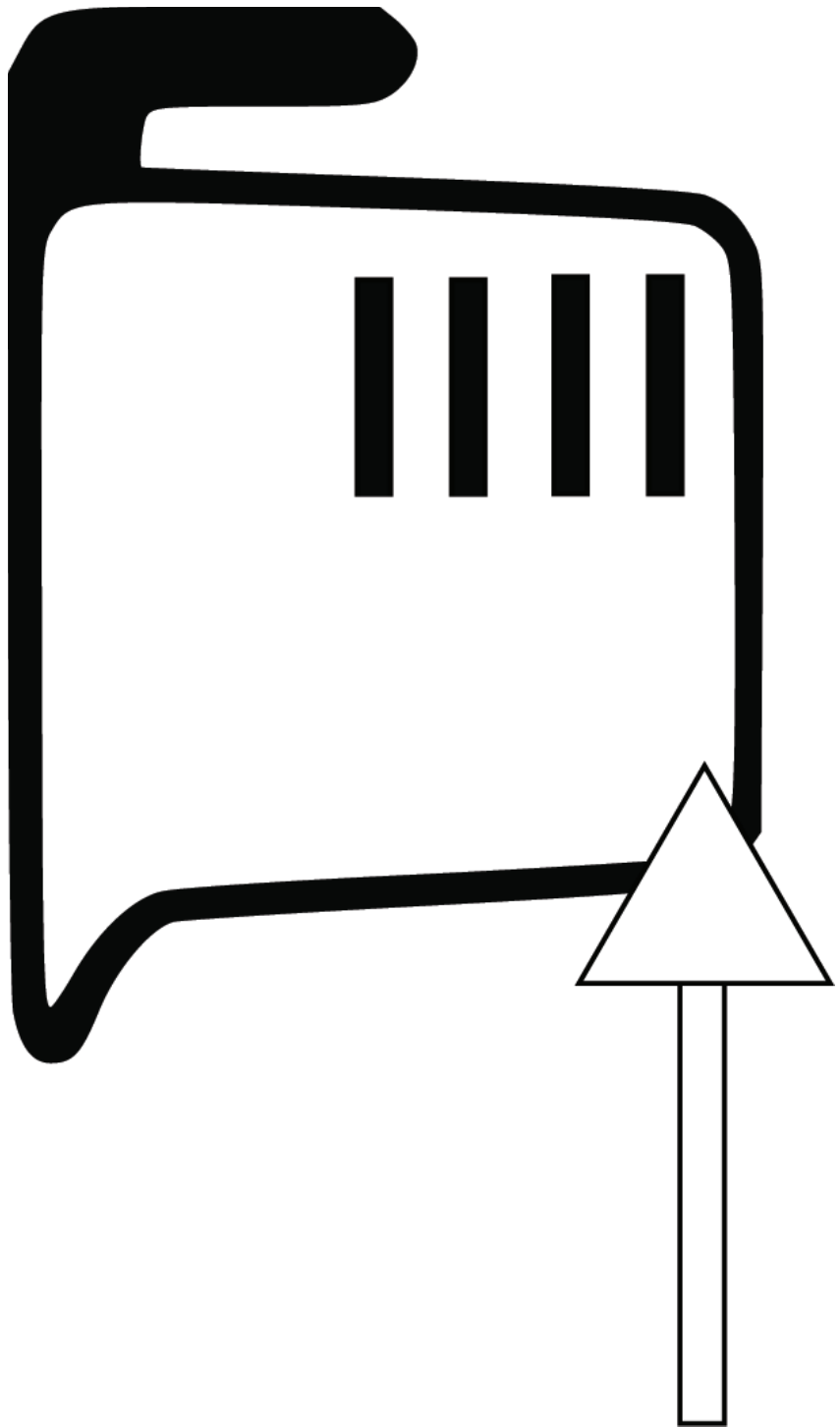

empty

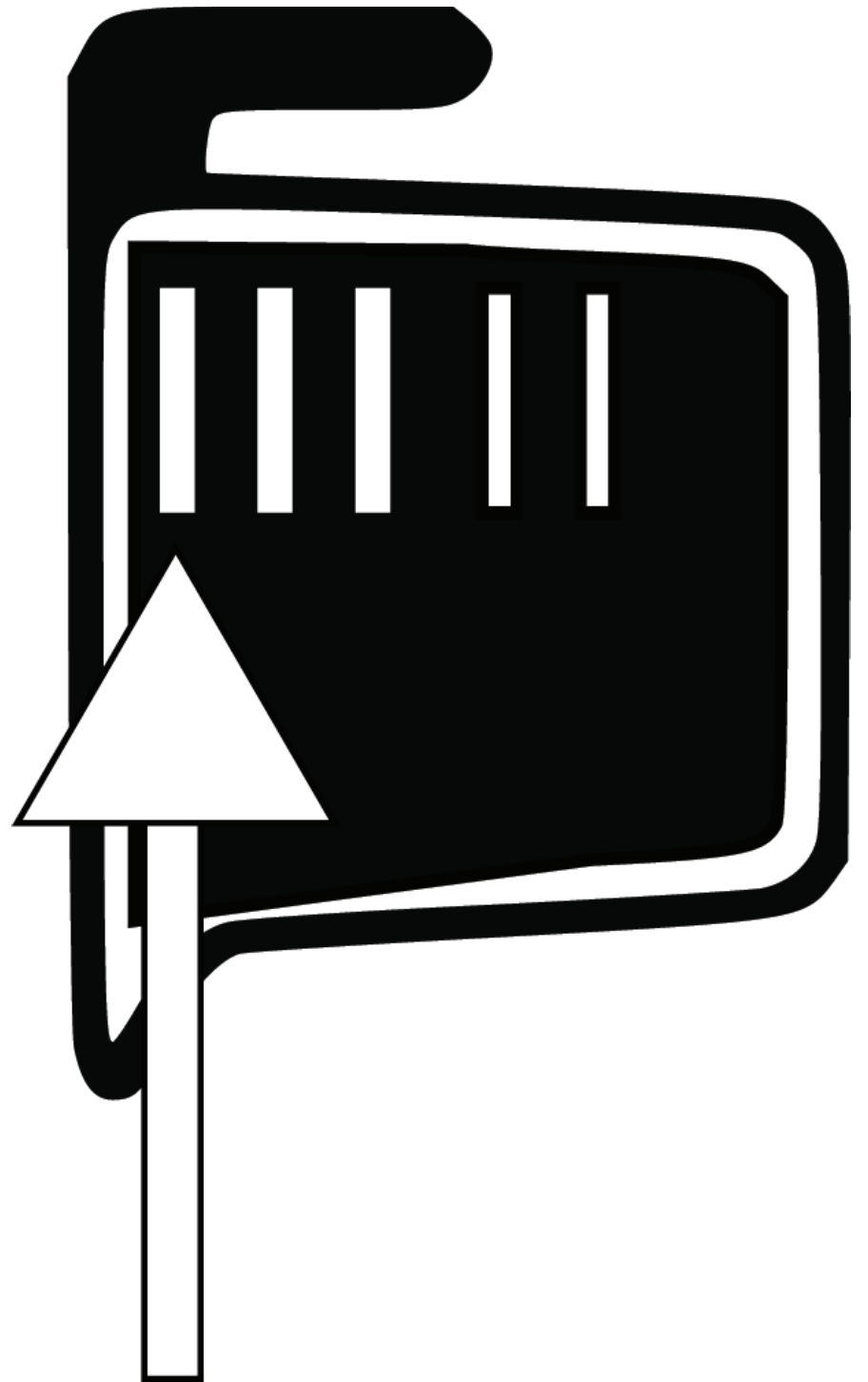

full

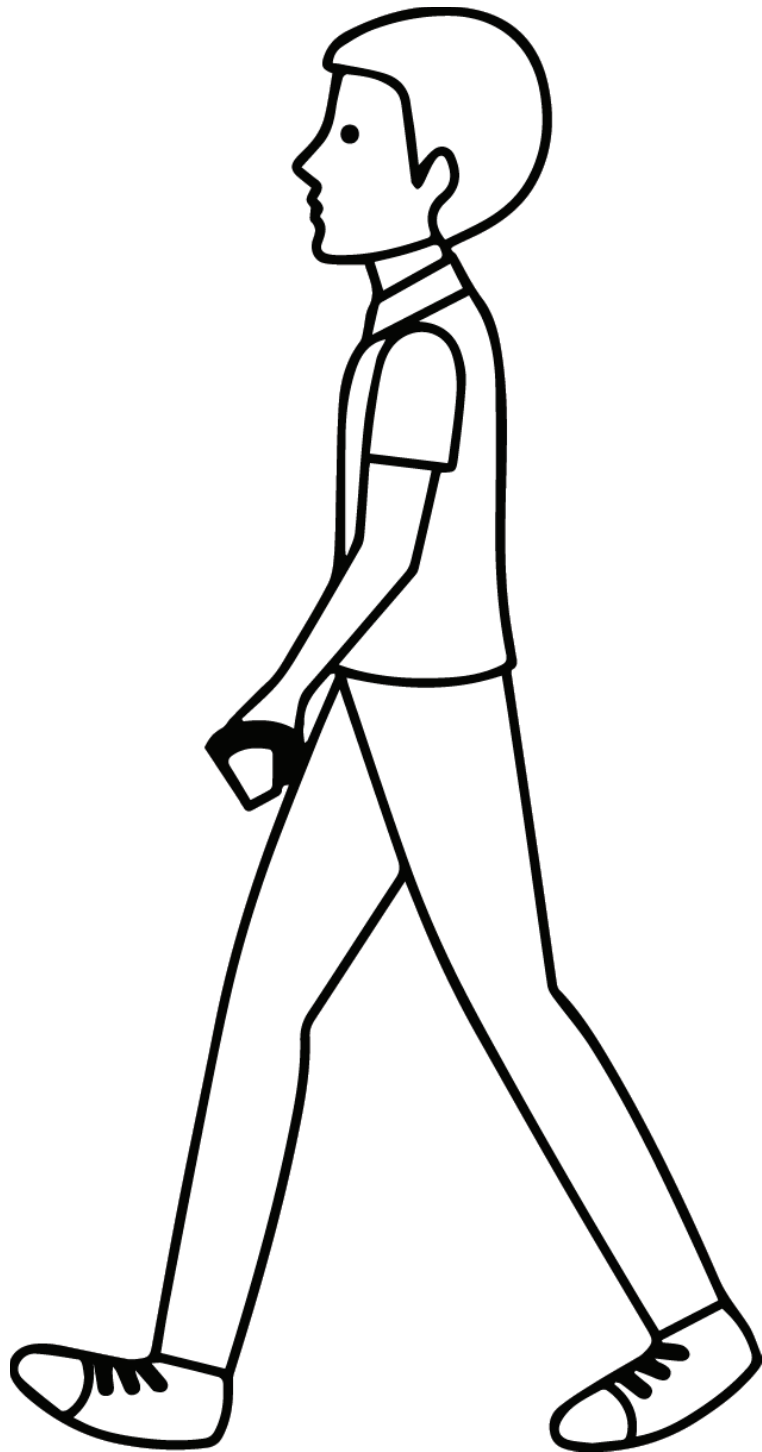

walk

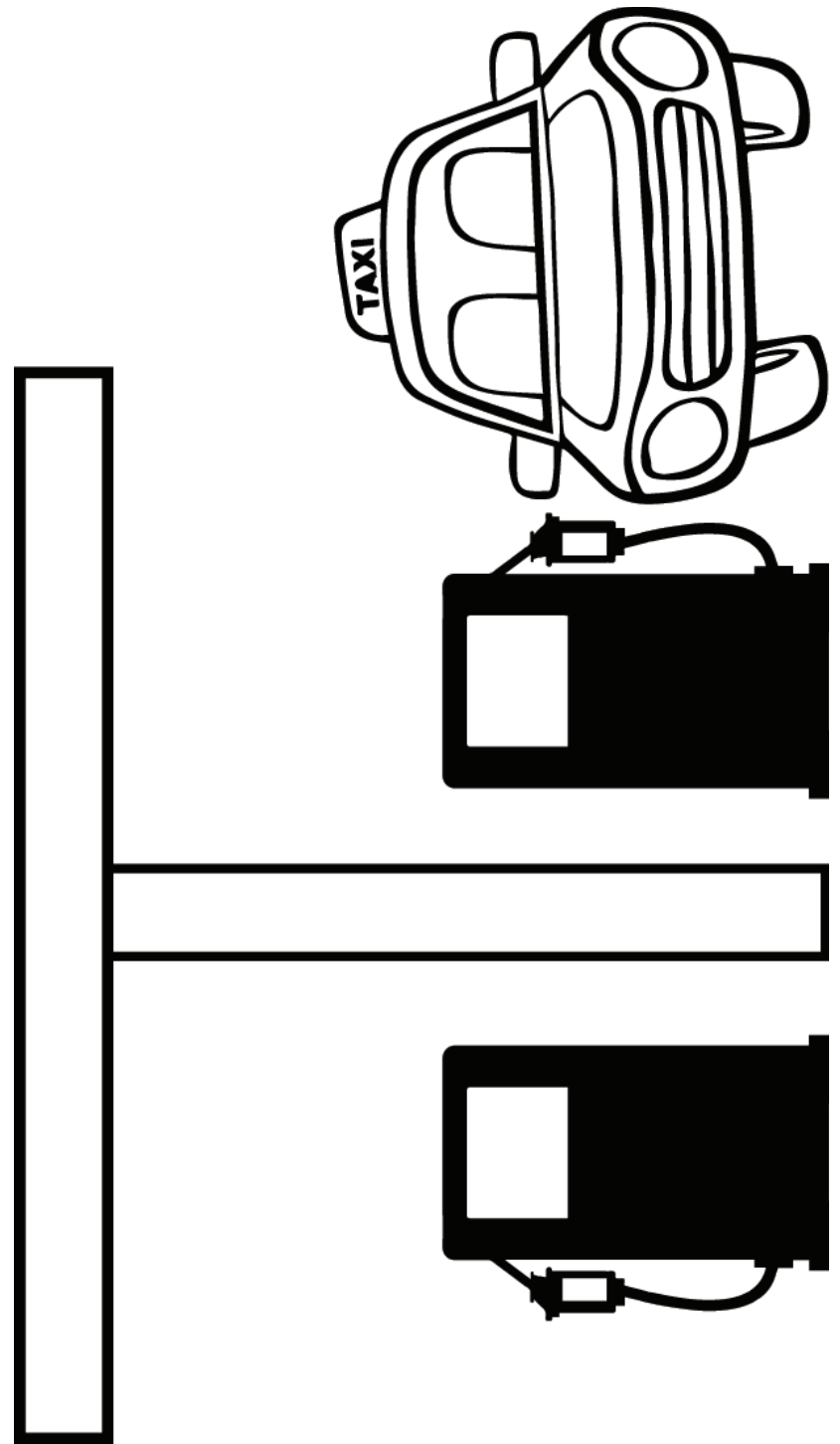

petrol station



path

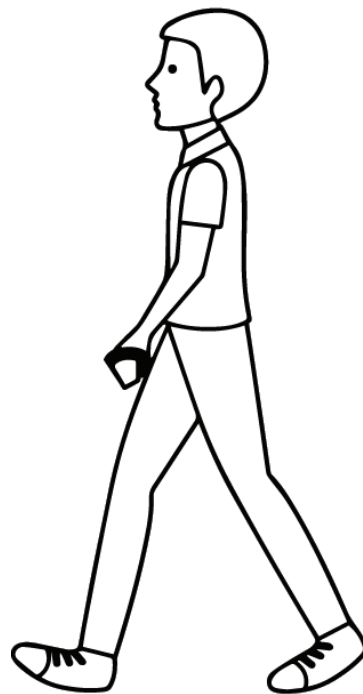

by foot





safe

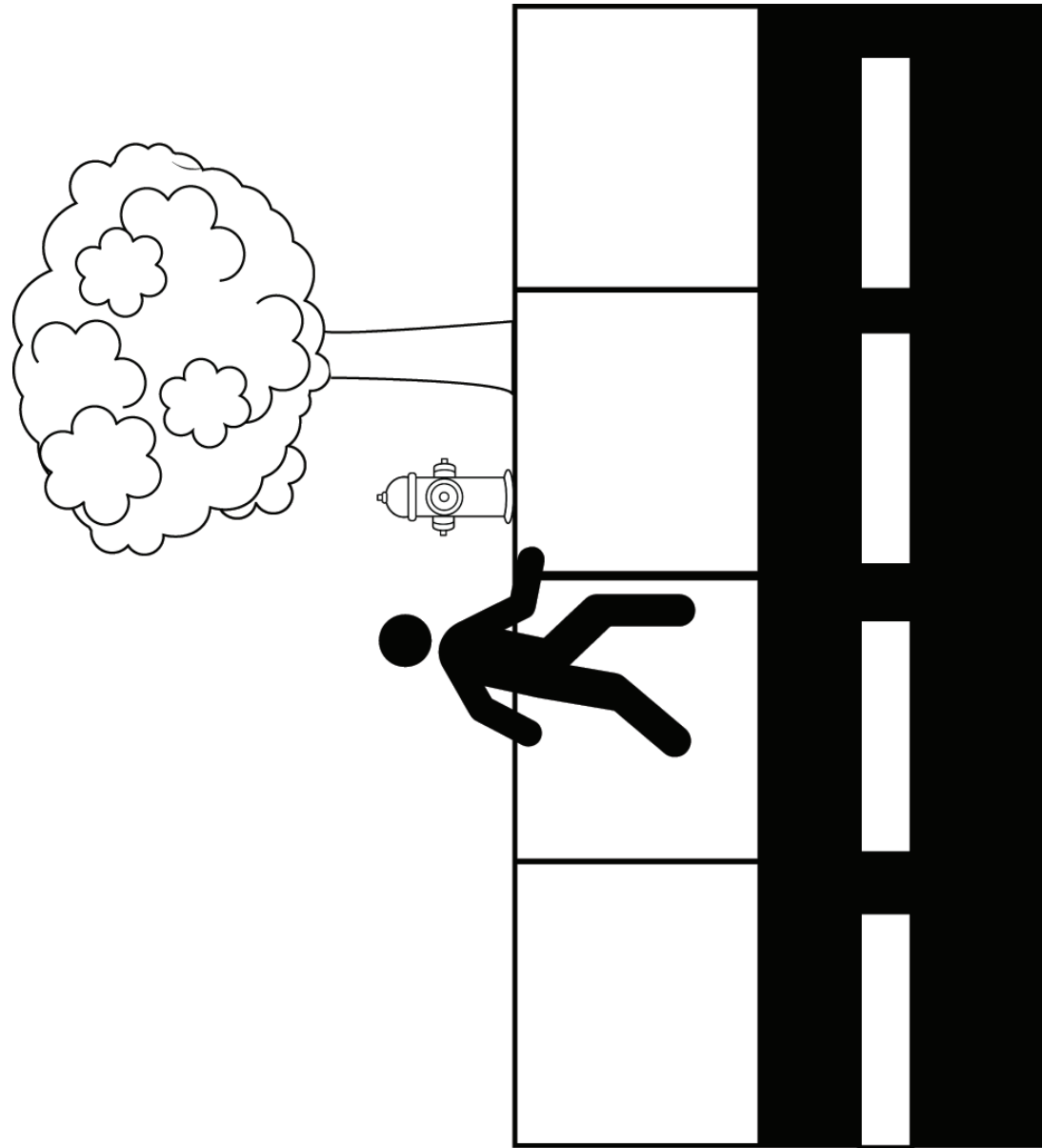

sidewalk

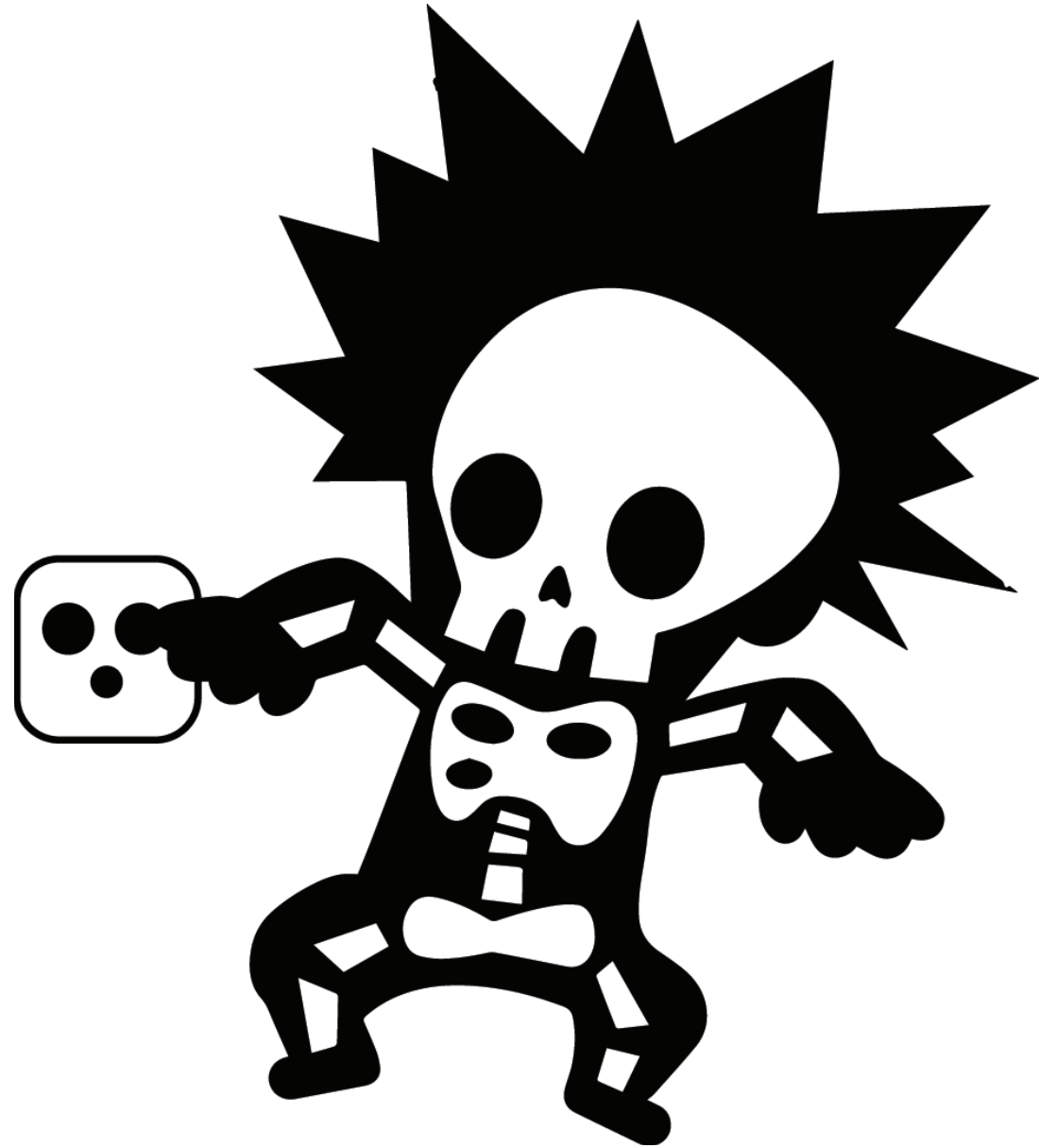

unsafe

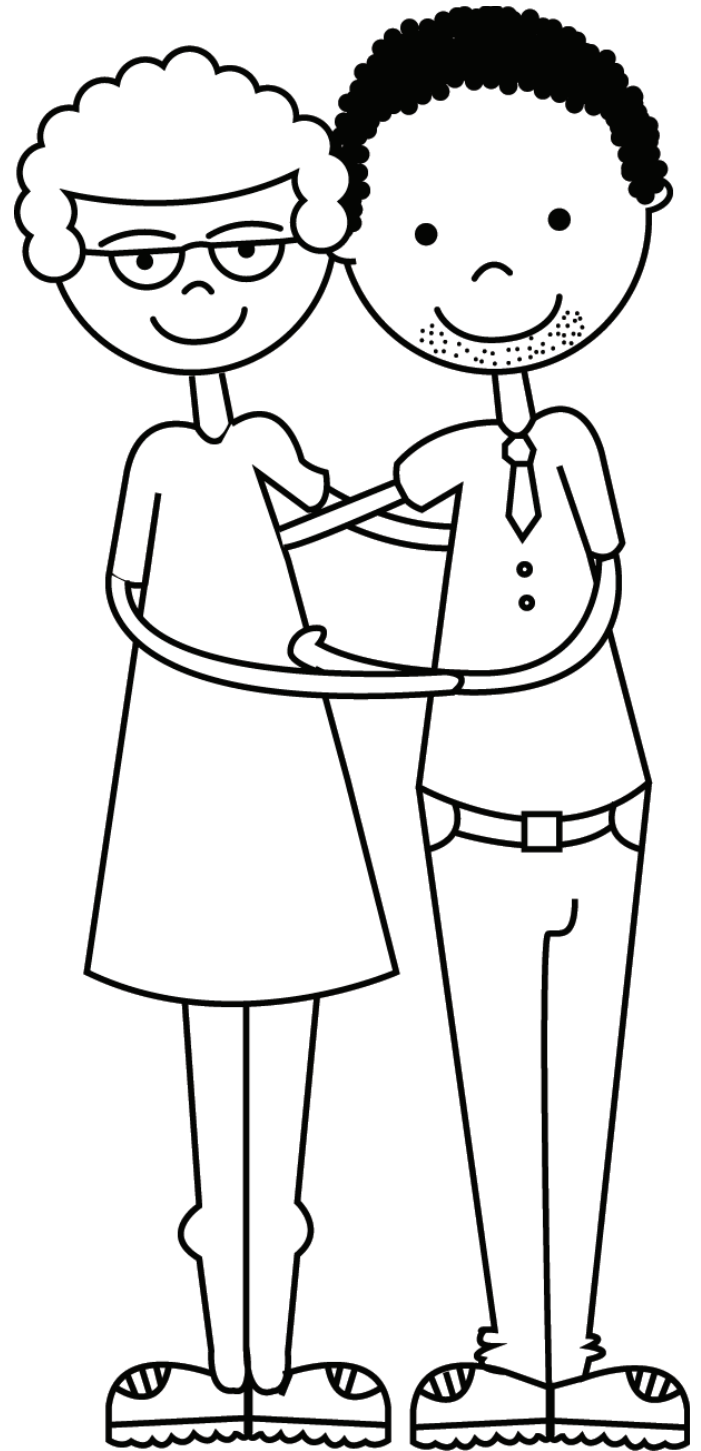

hug

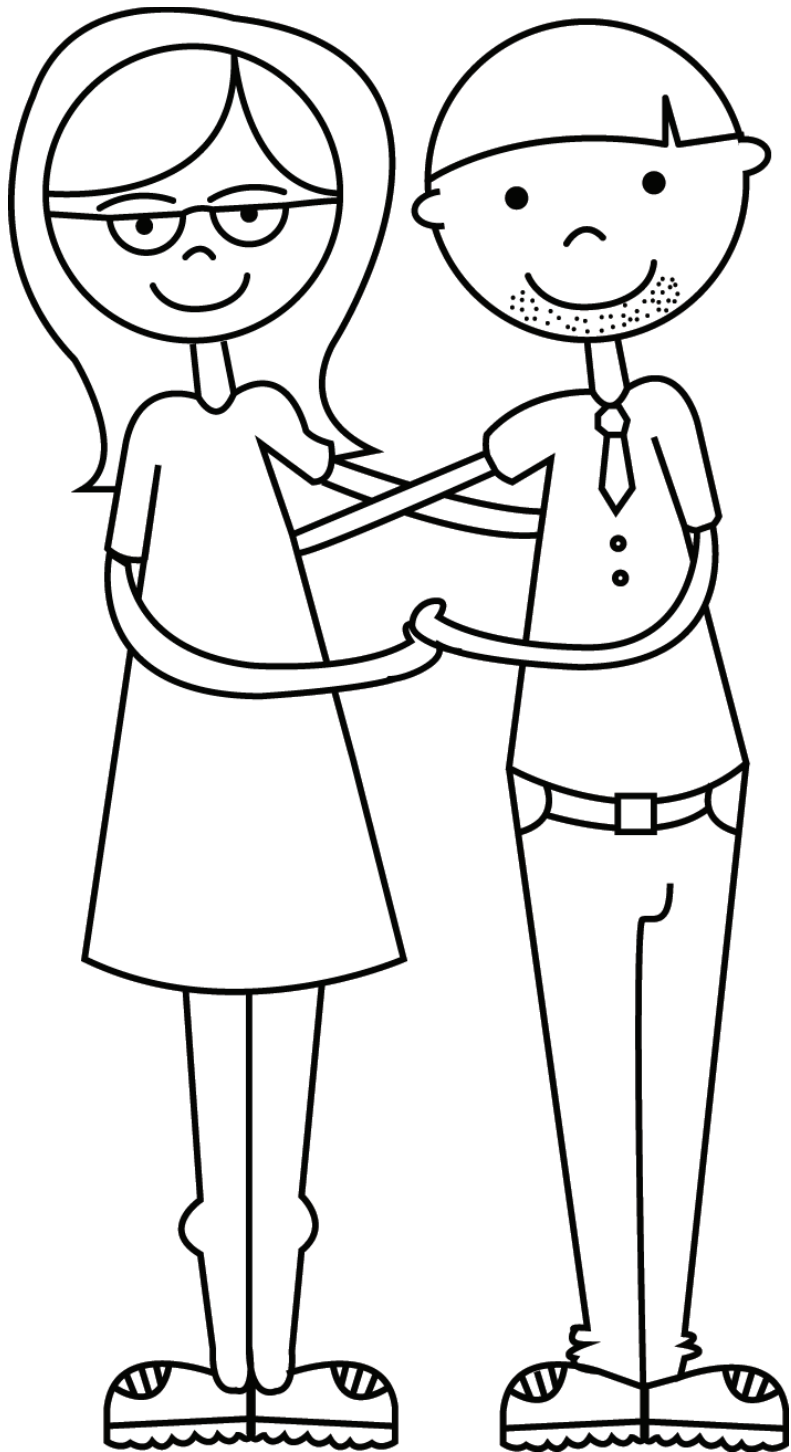

together

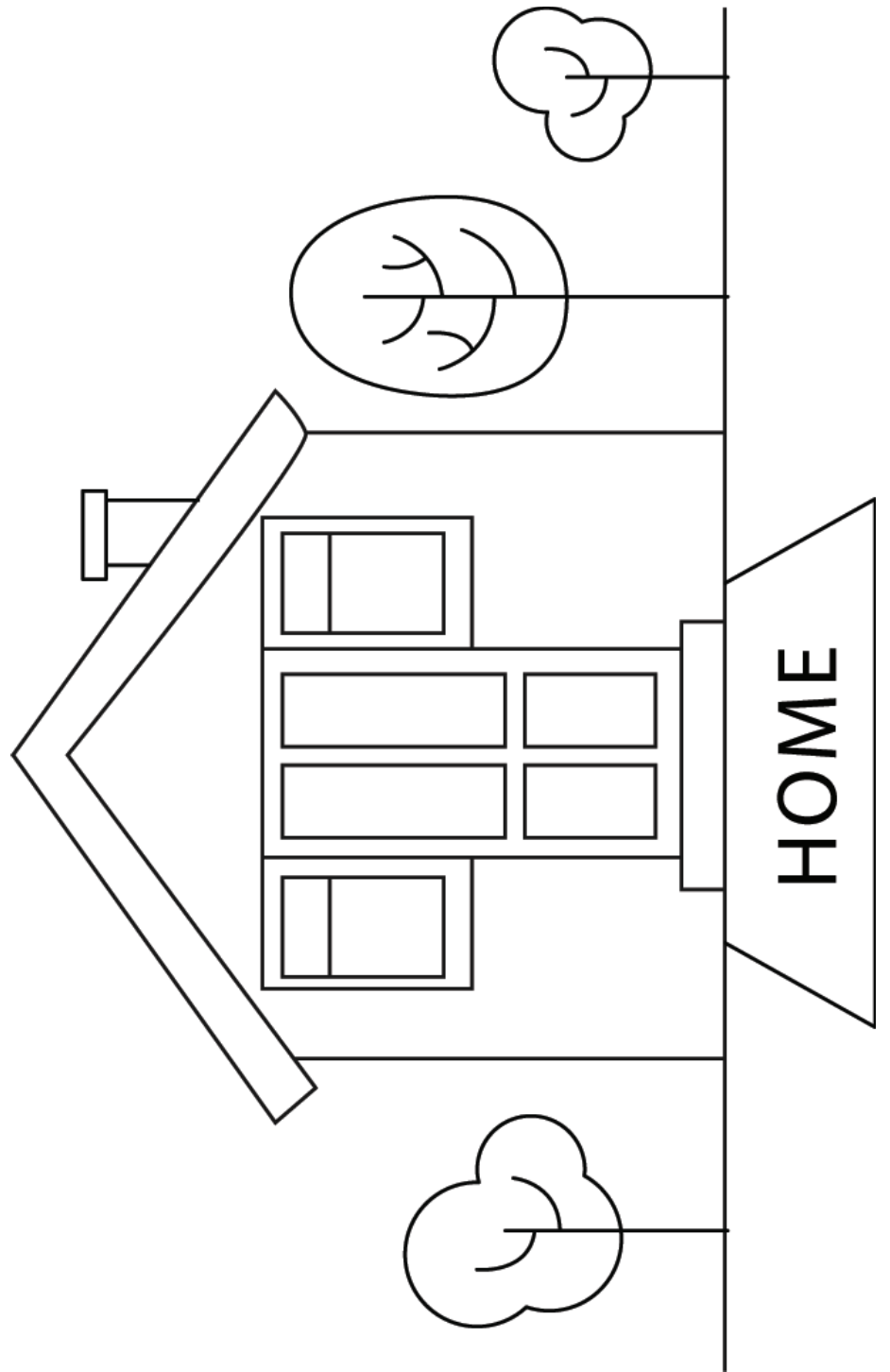

home



shop

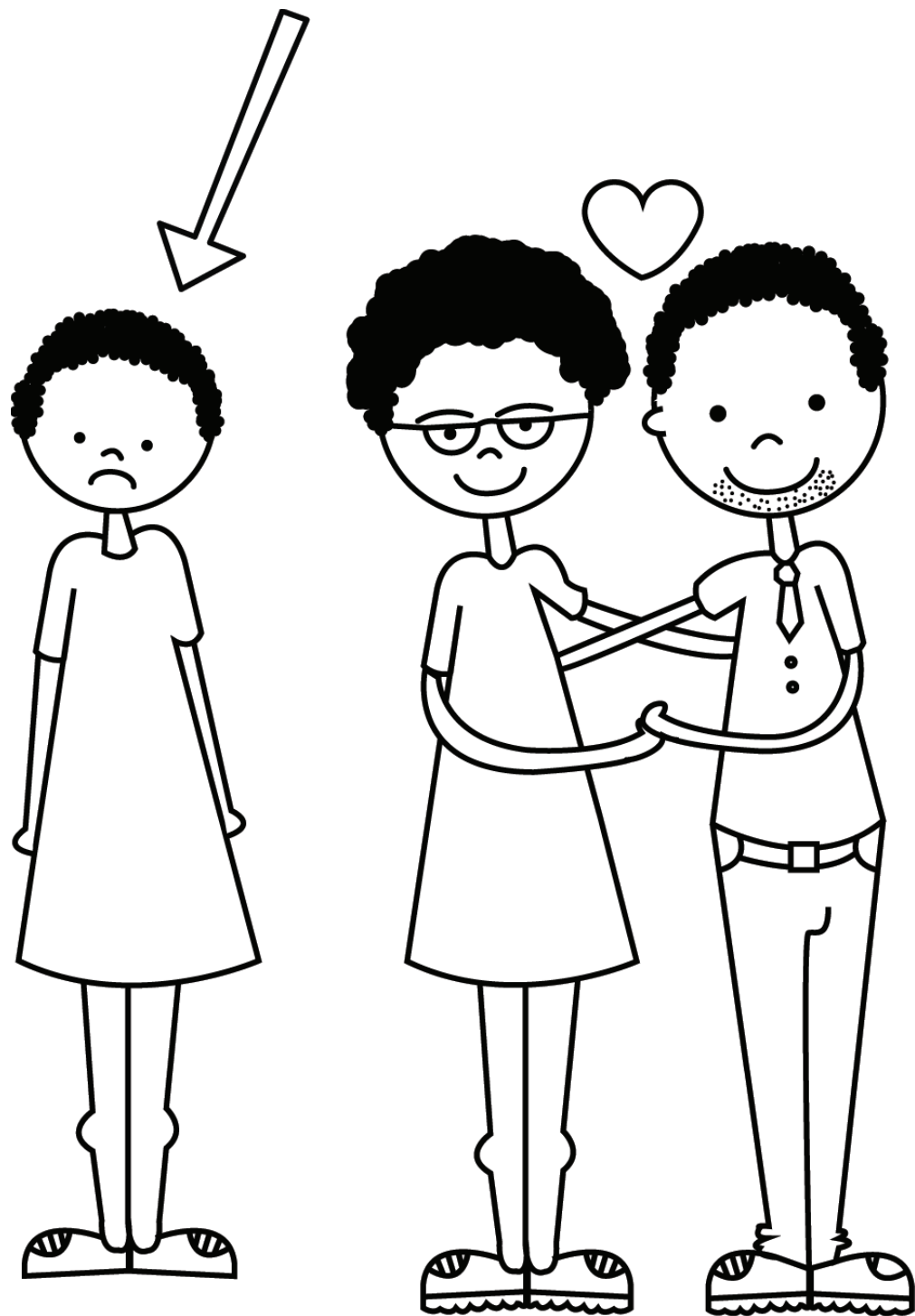

alone

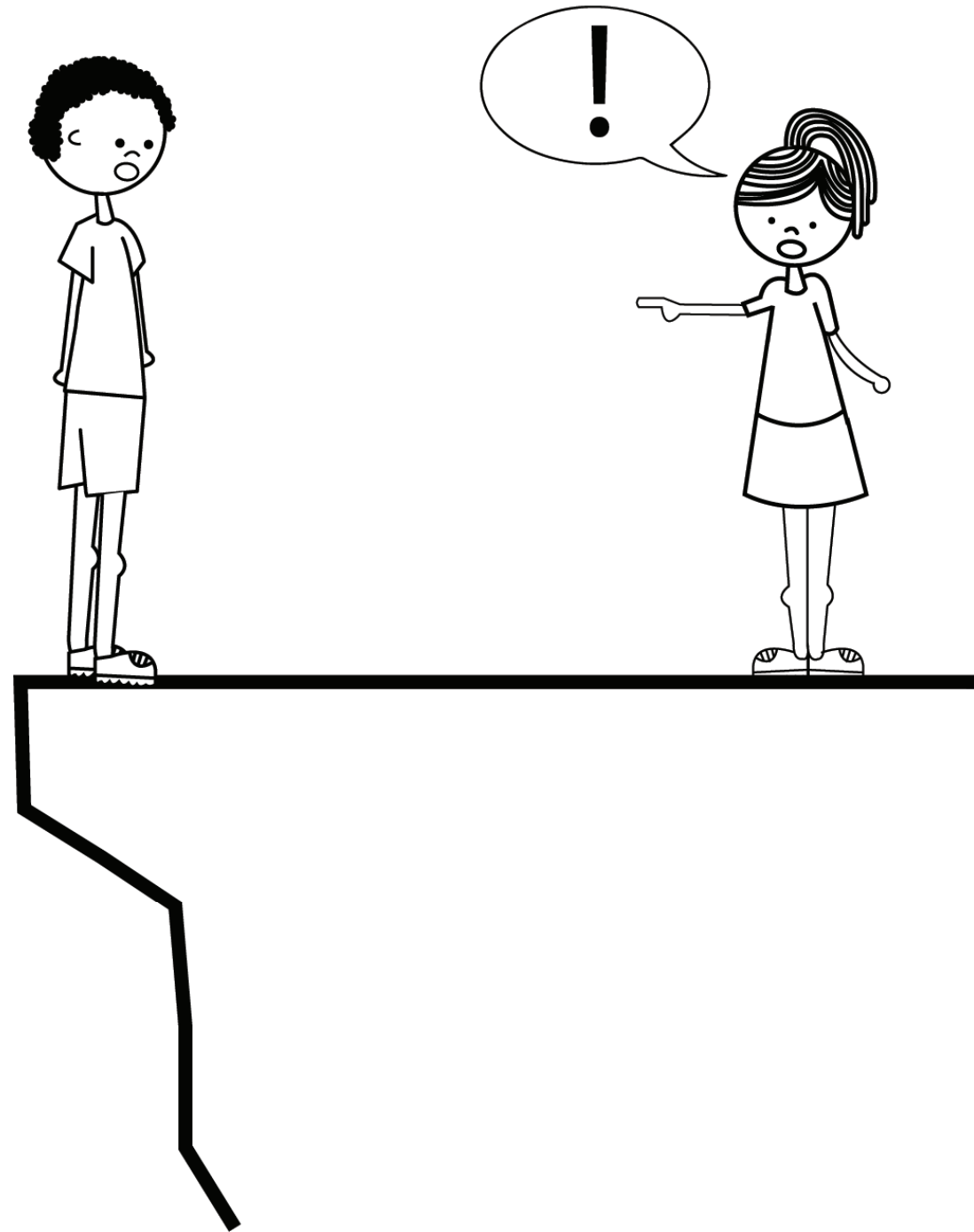

warn

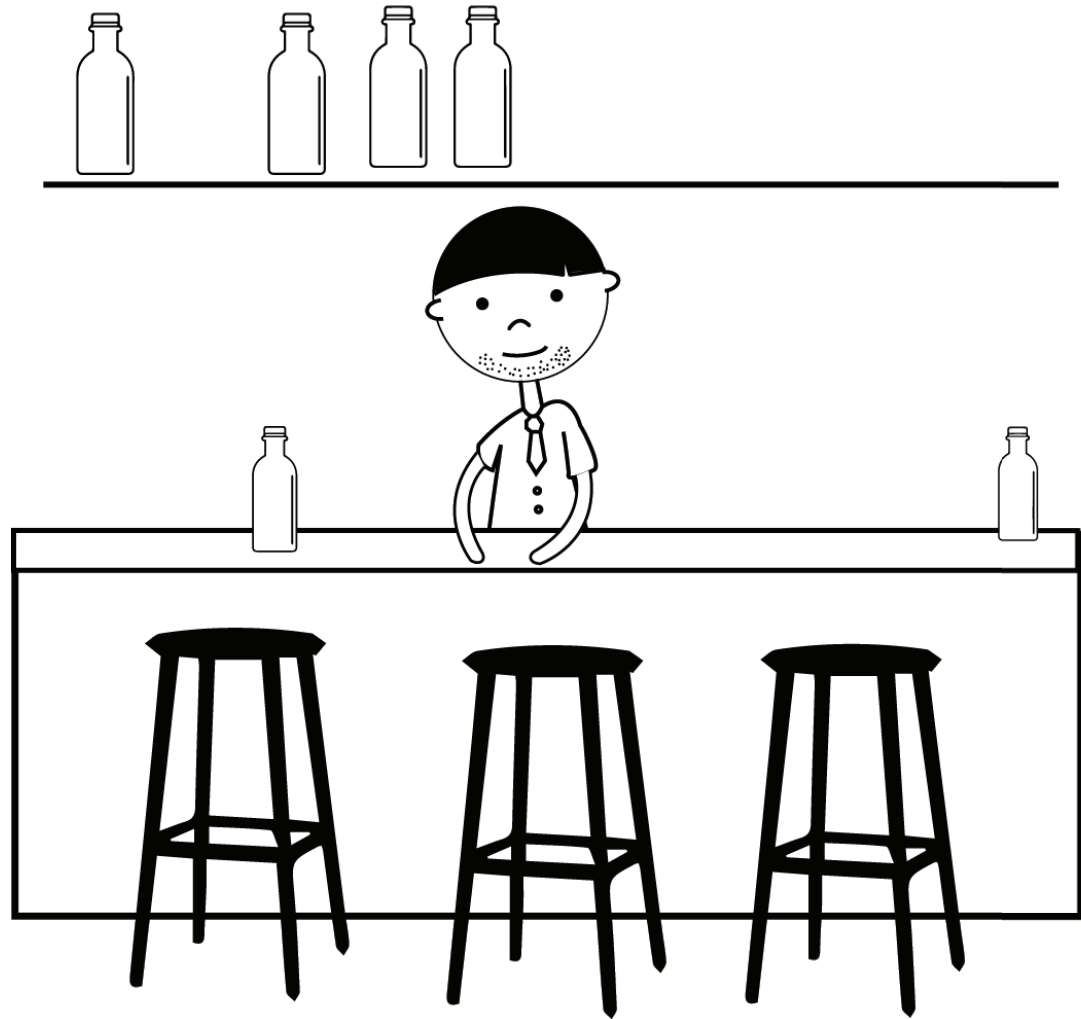

shebeen

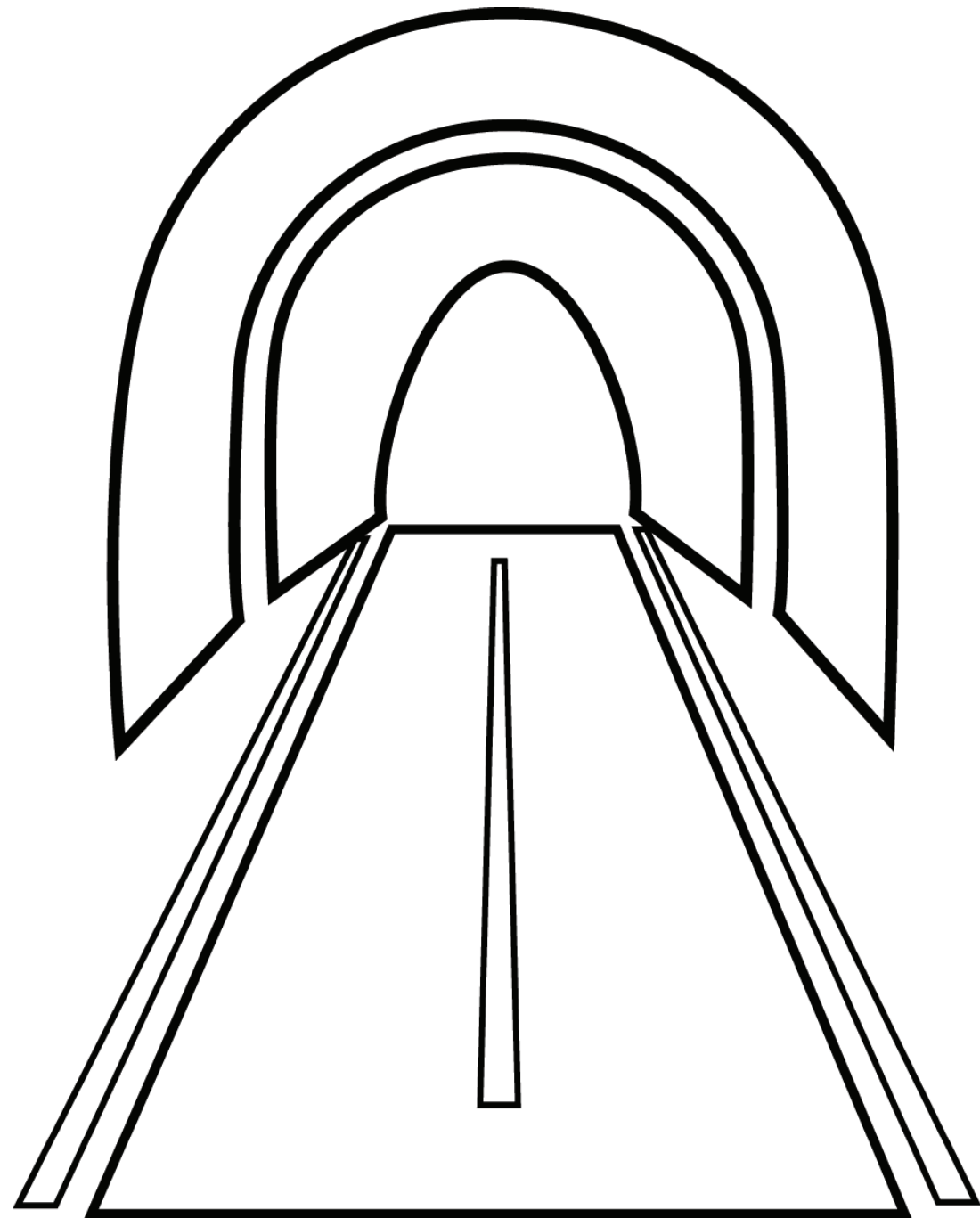

passage

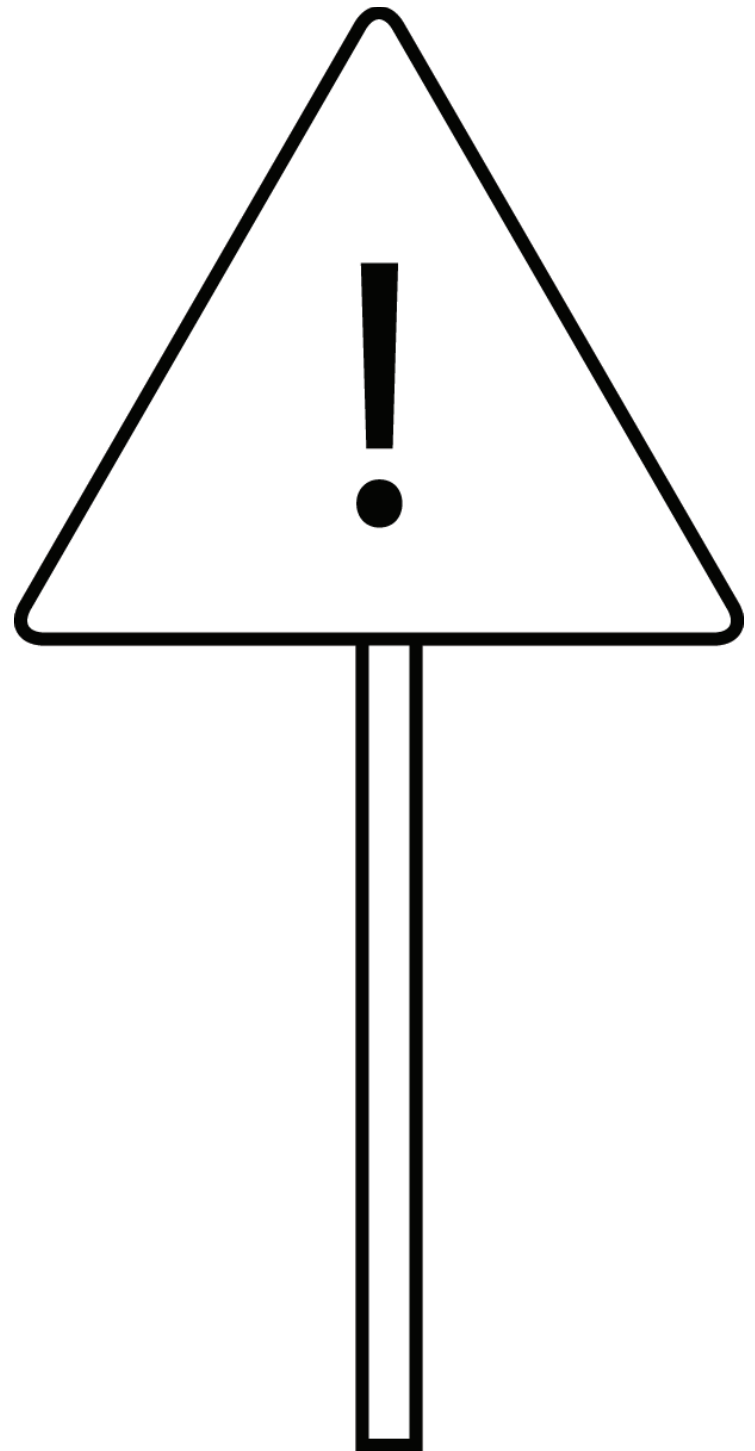

warning

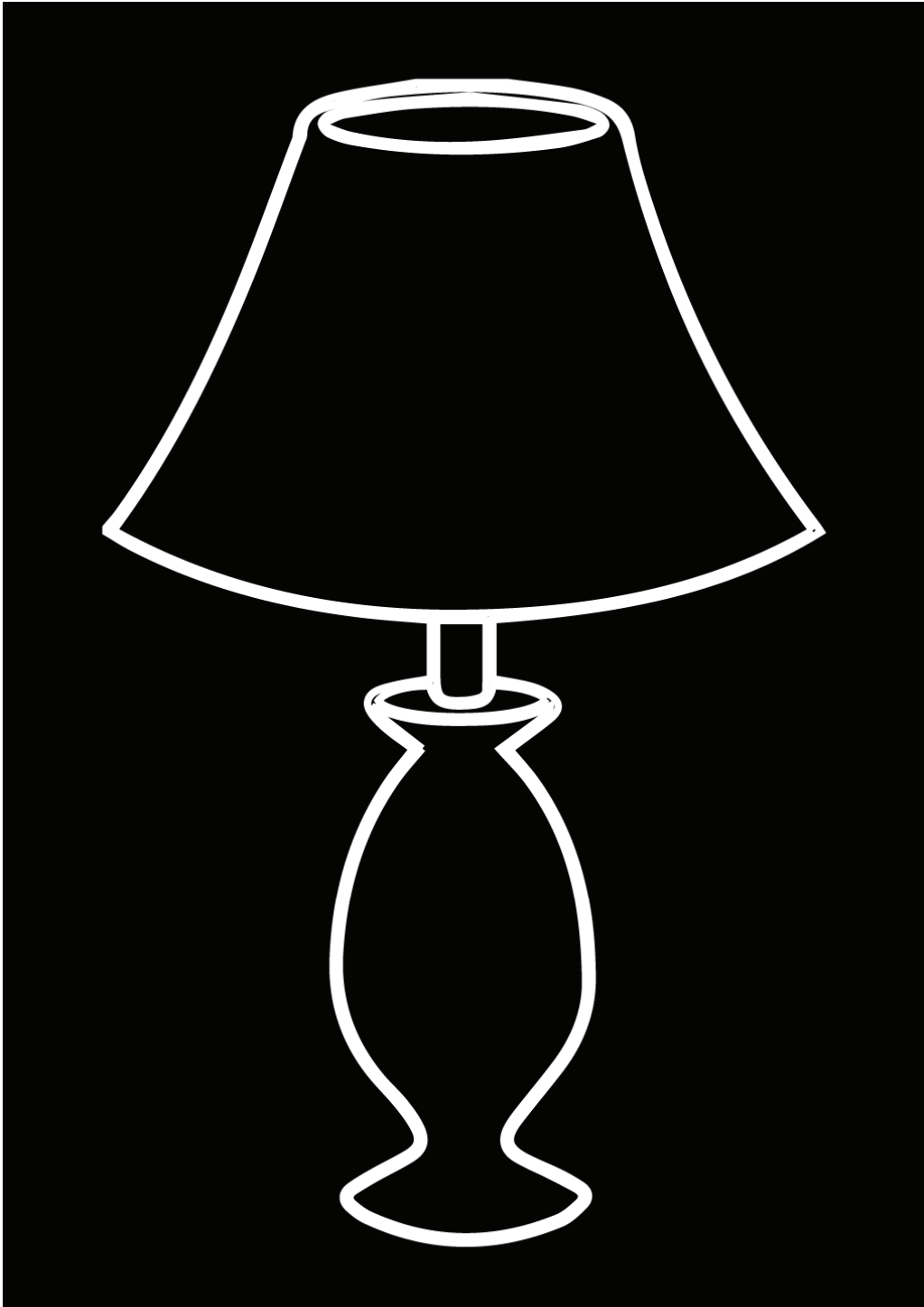

dark

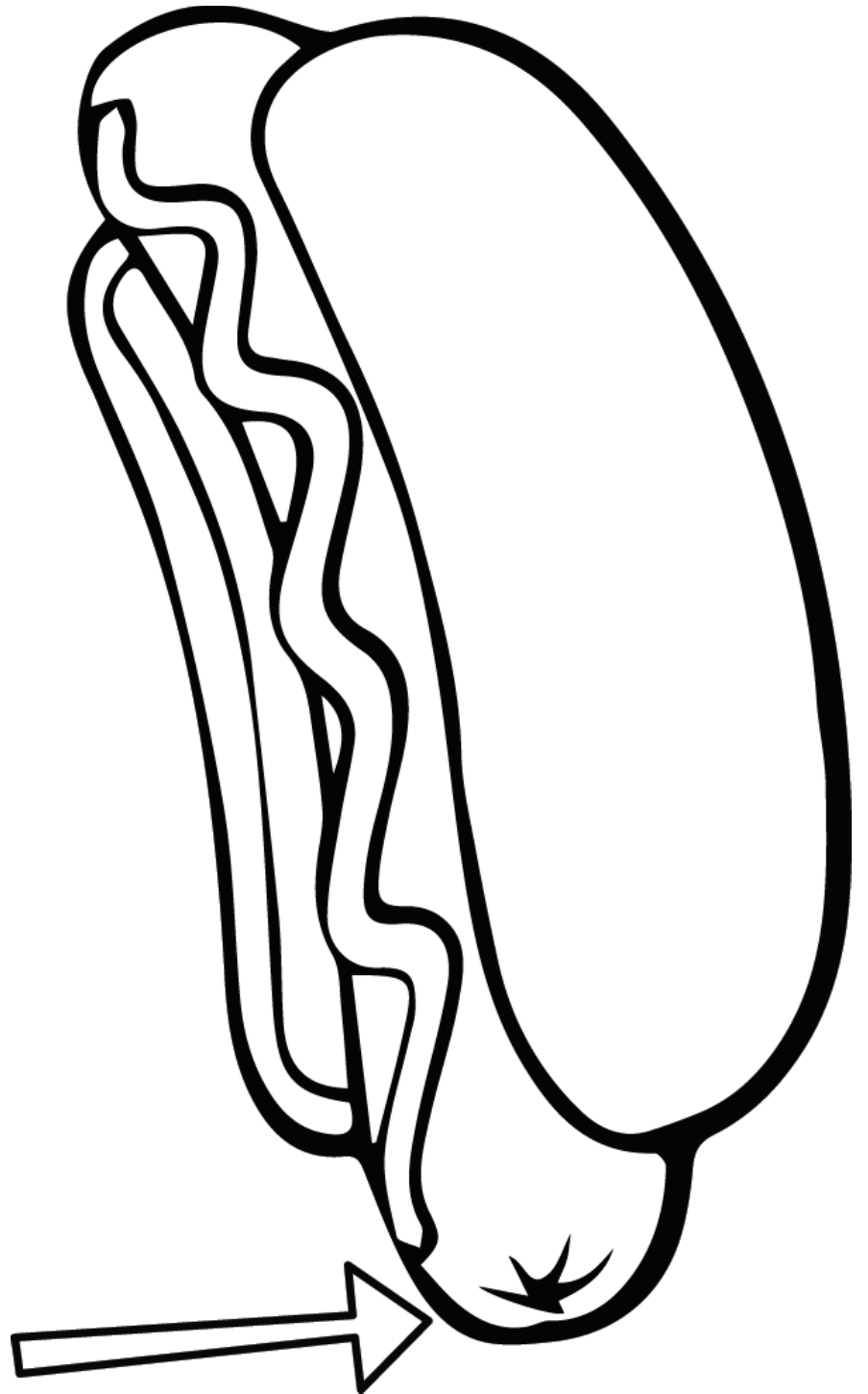

between

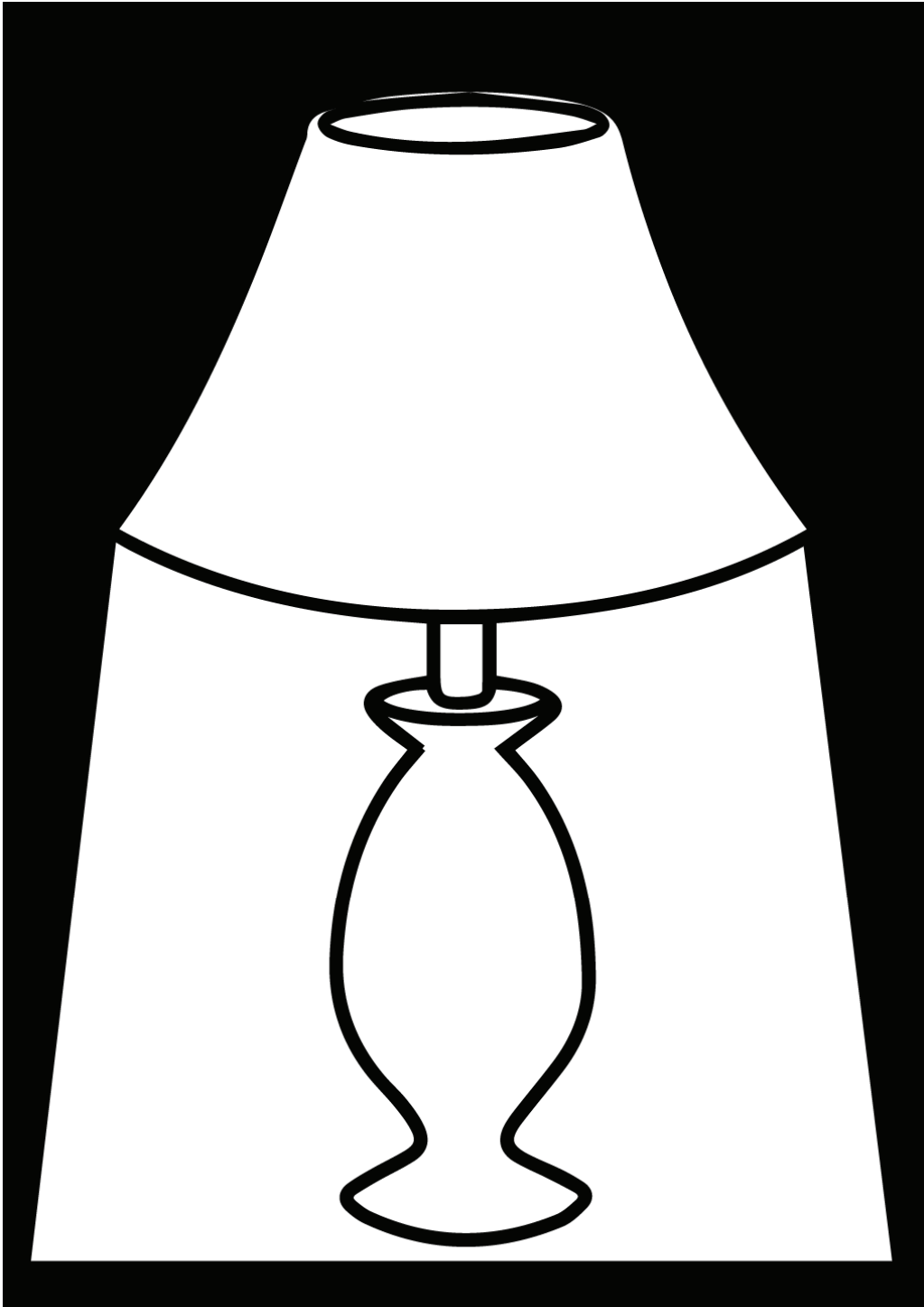

light

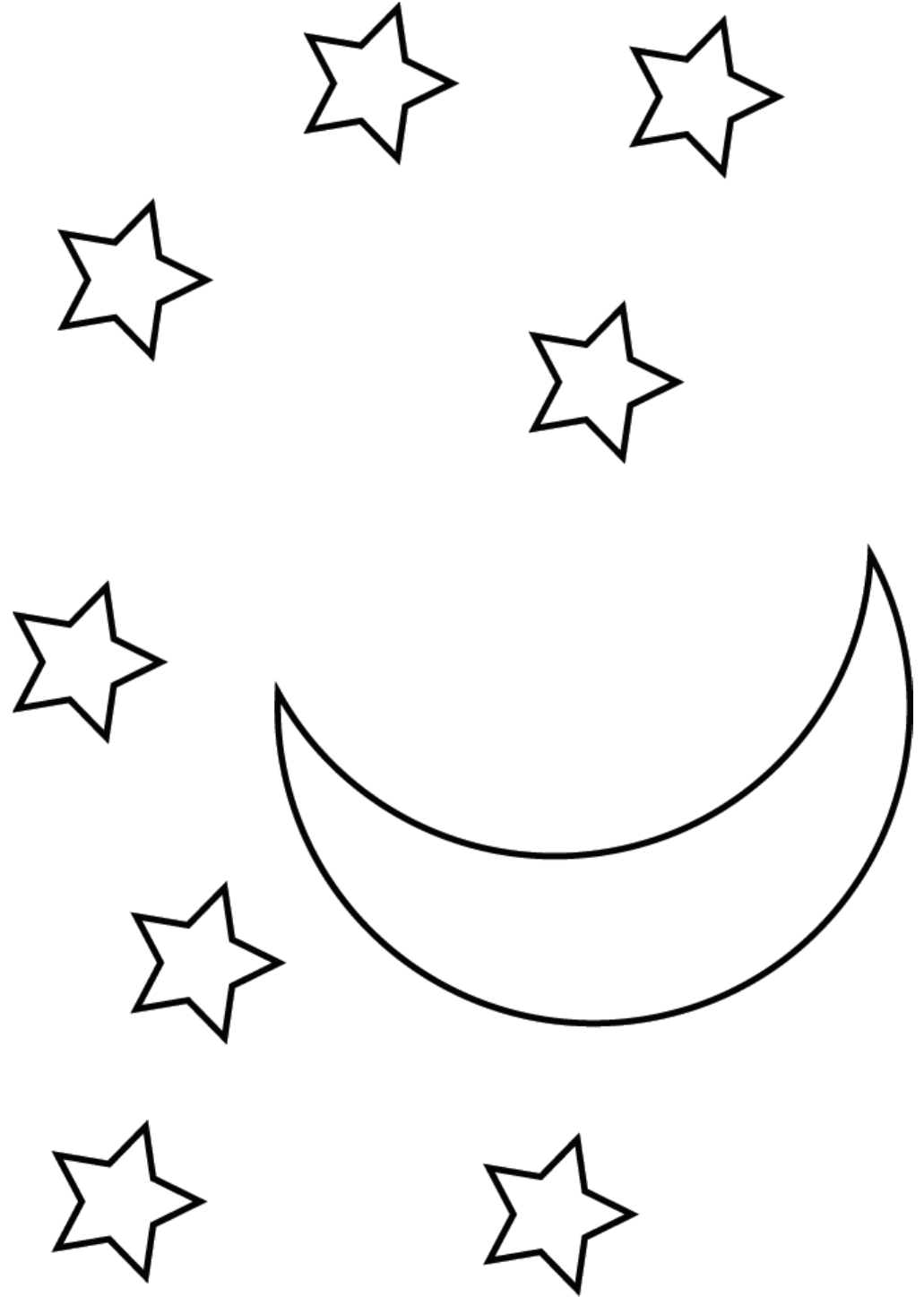

night

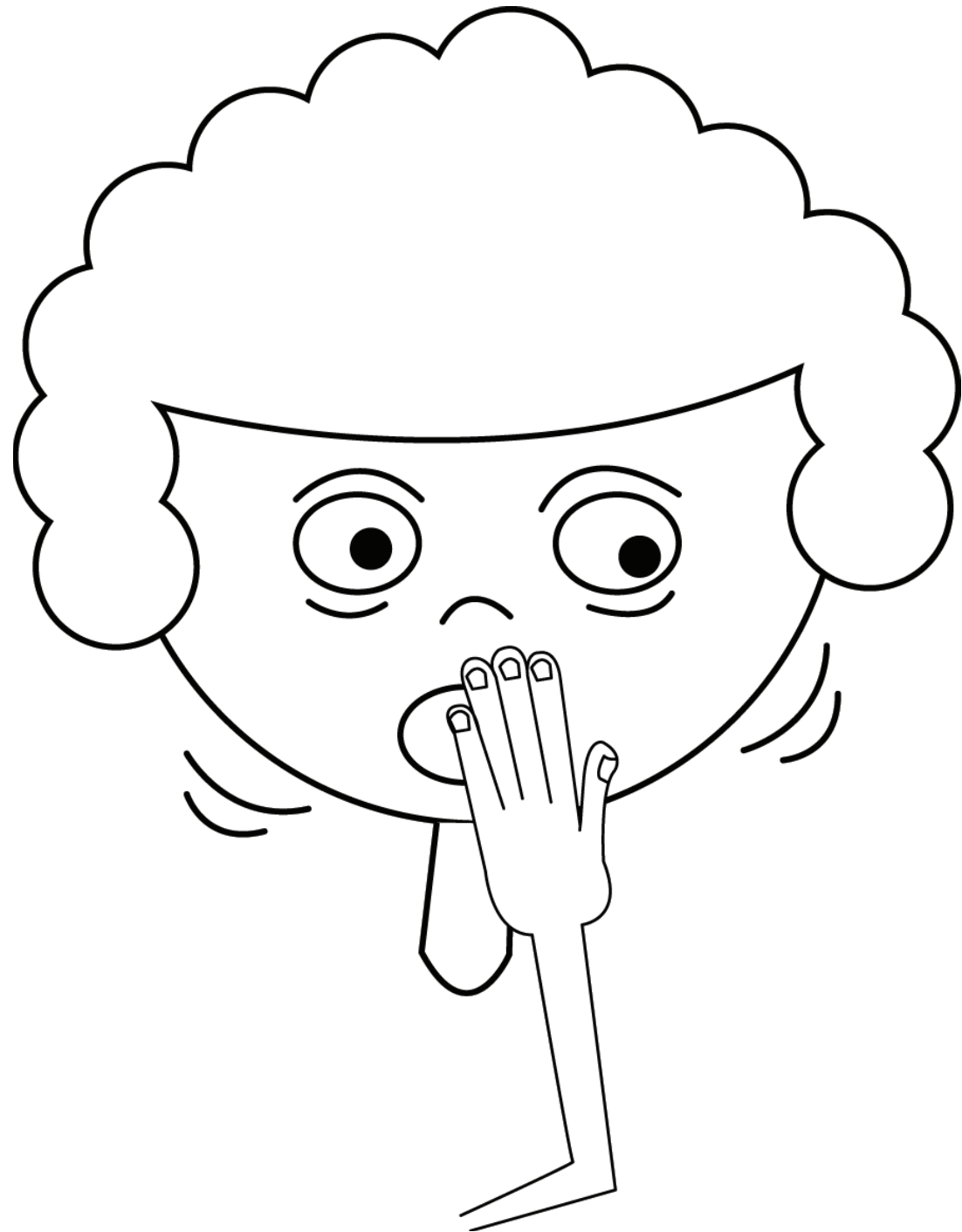

worried

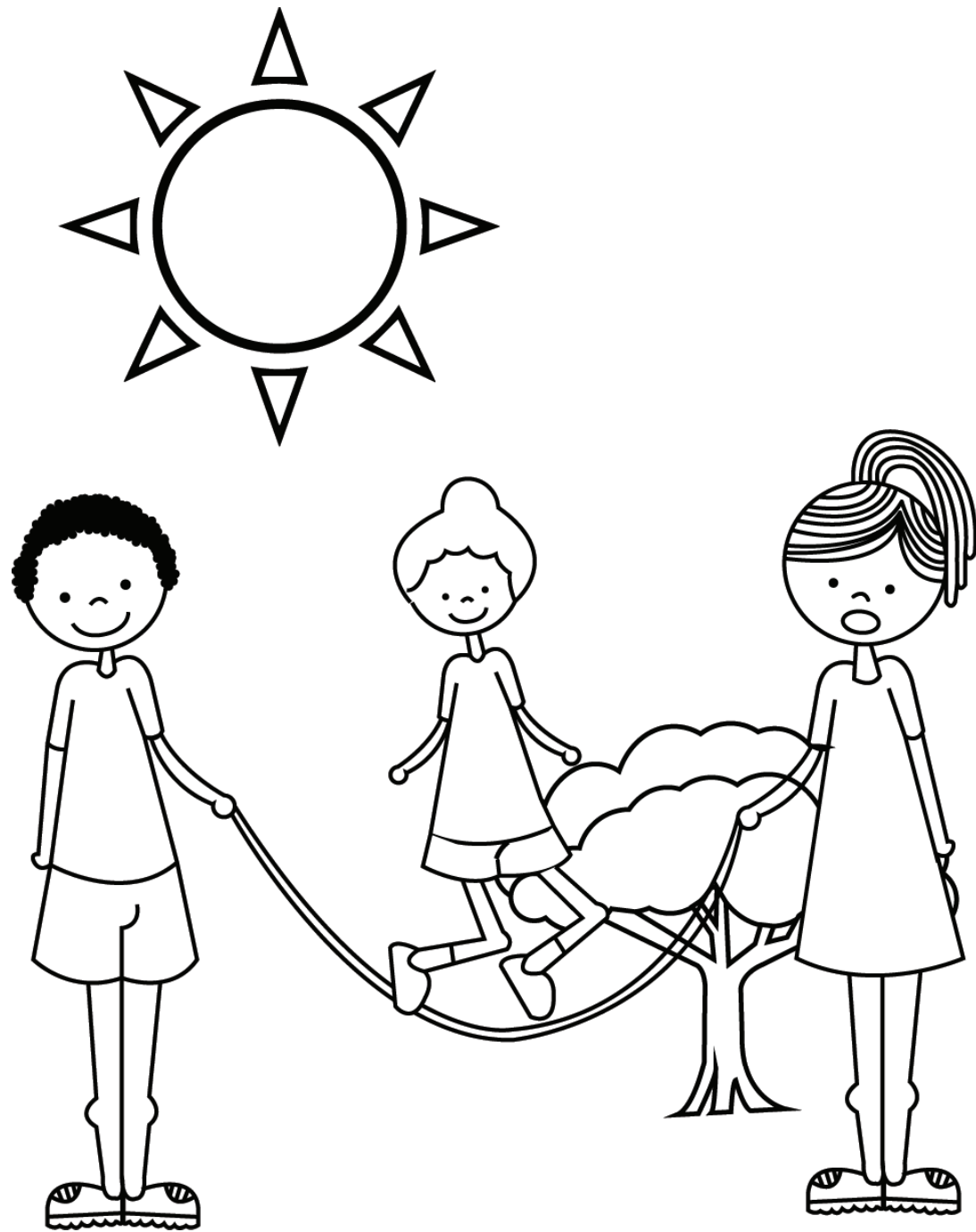

day

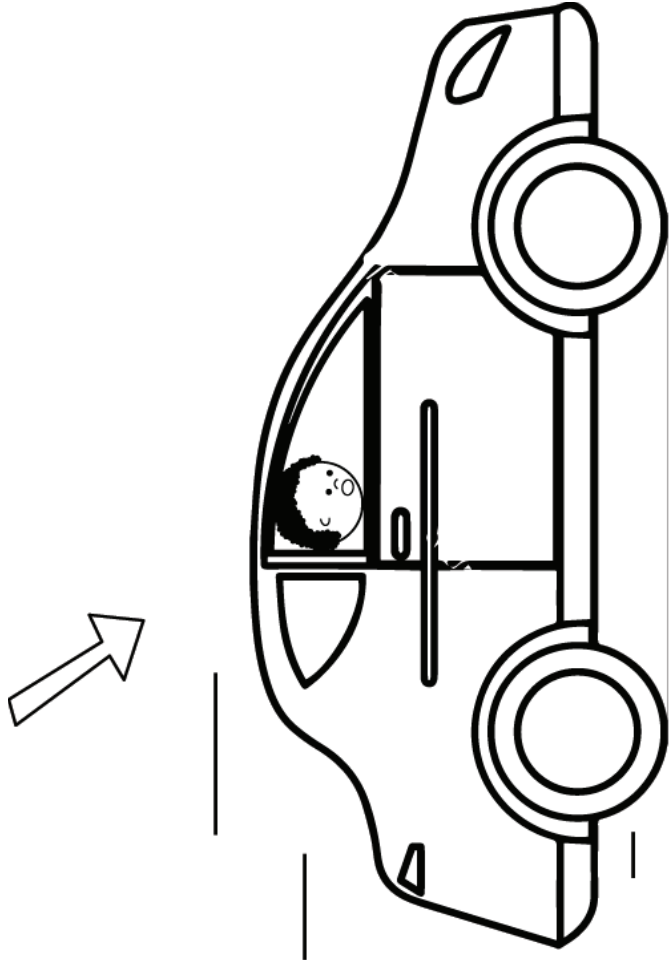

faster

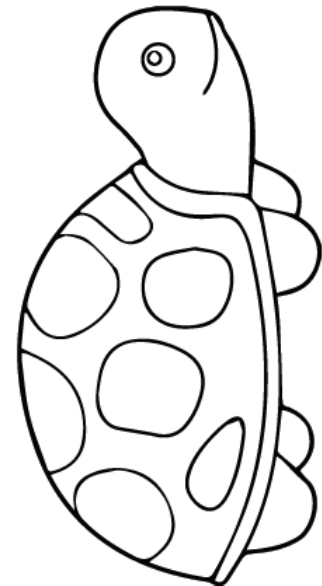
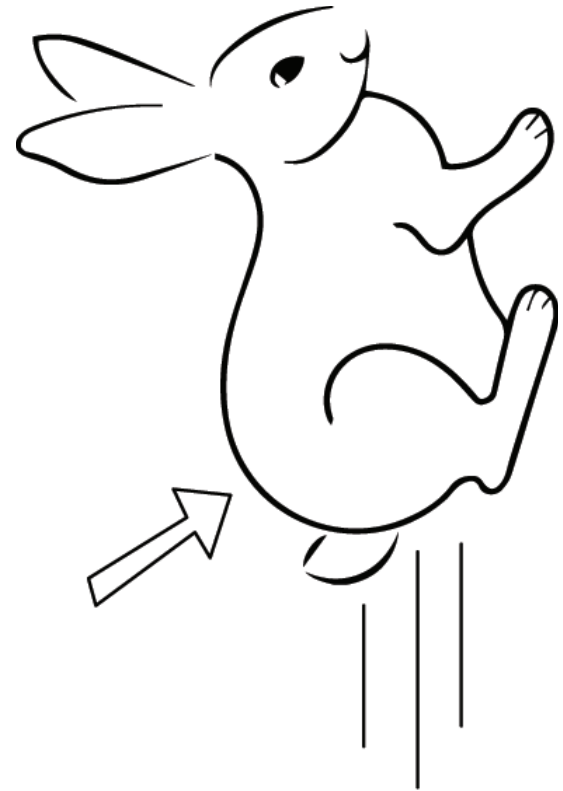

fast



run

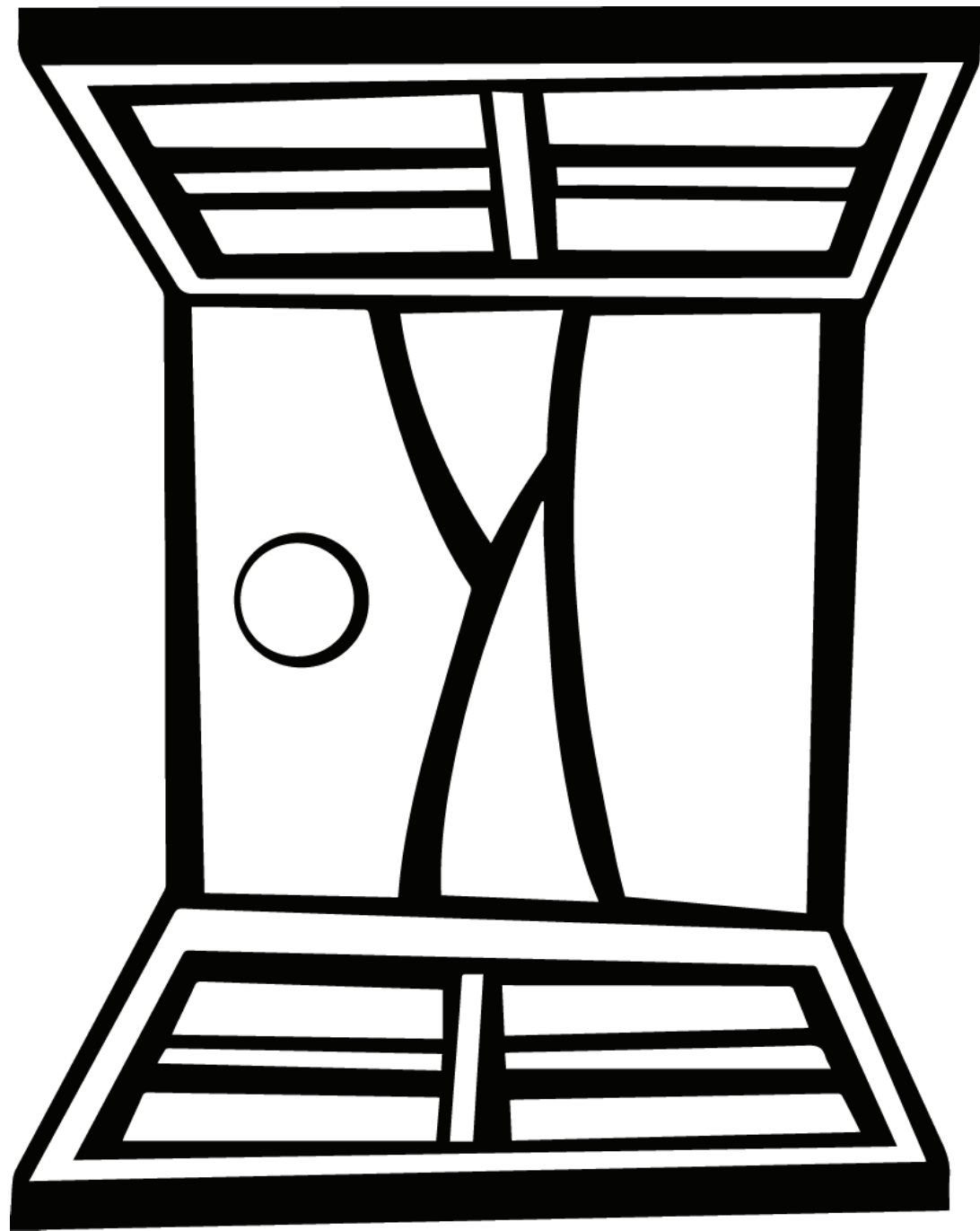

window

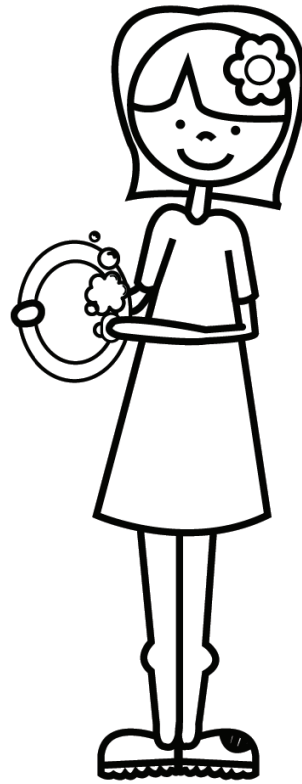
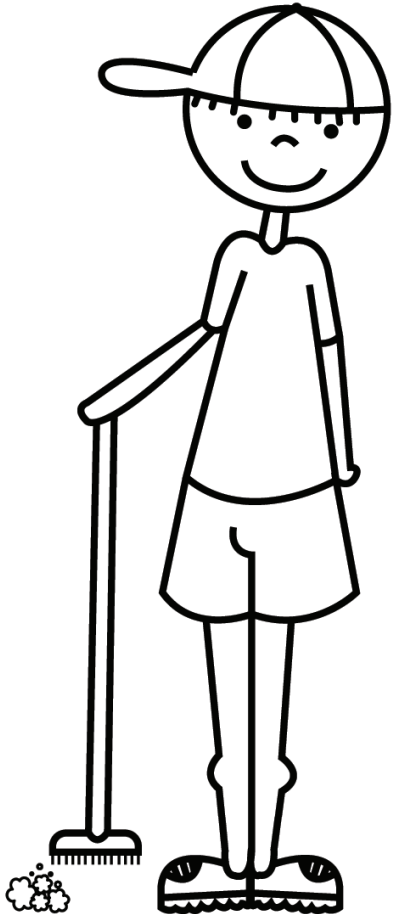
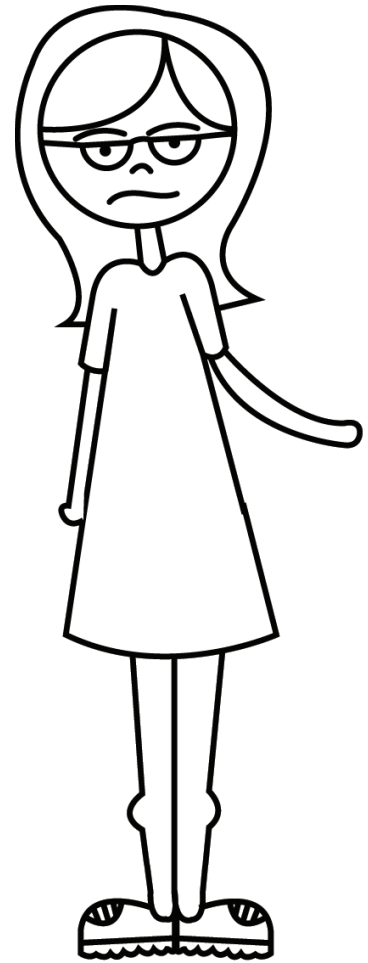

help



work

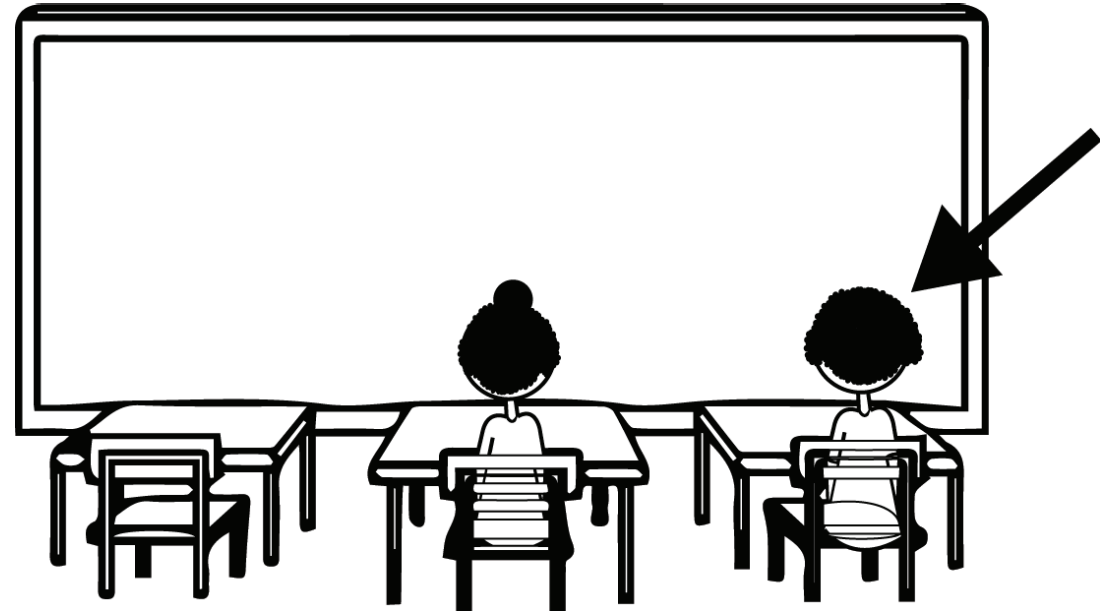

classmate

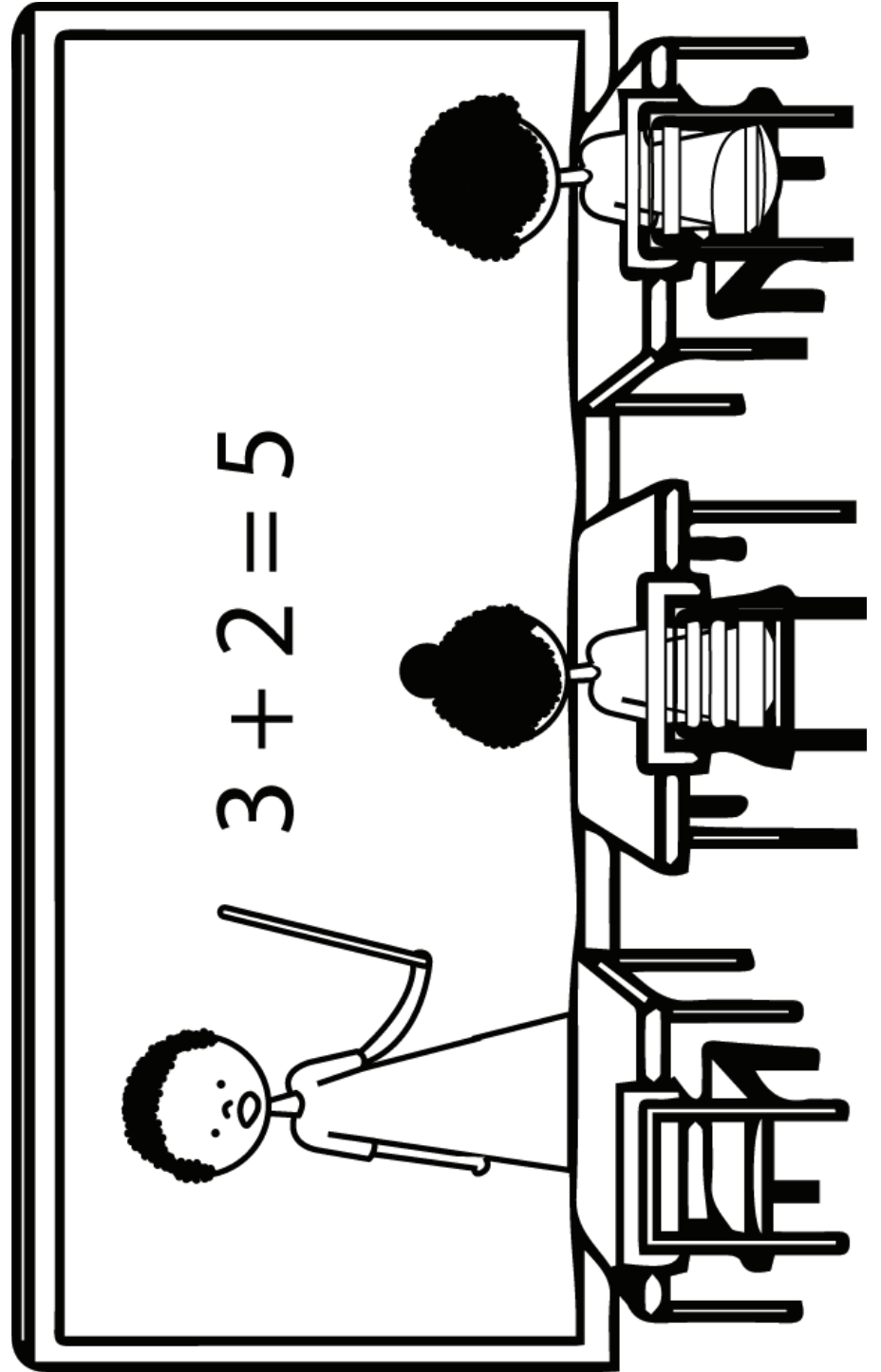

class

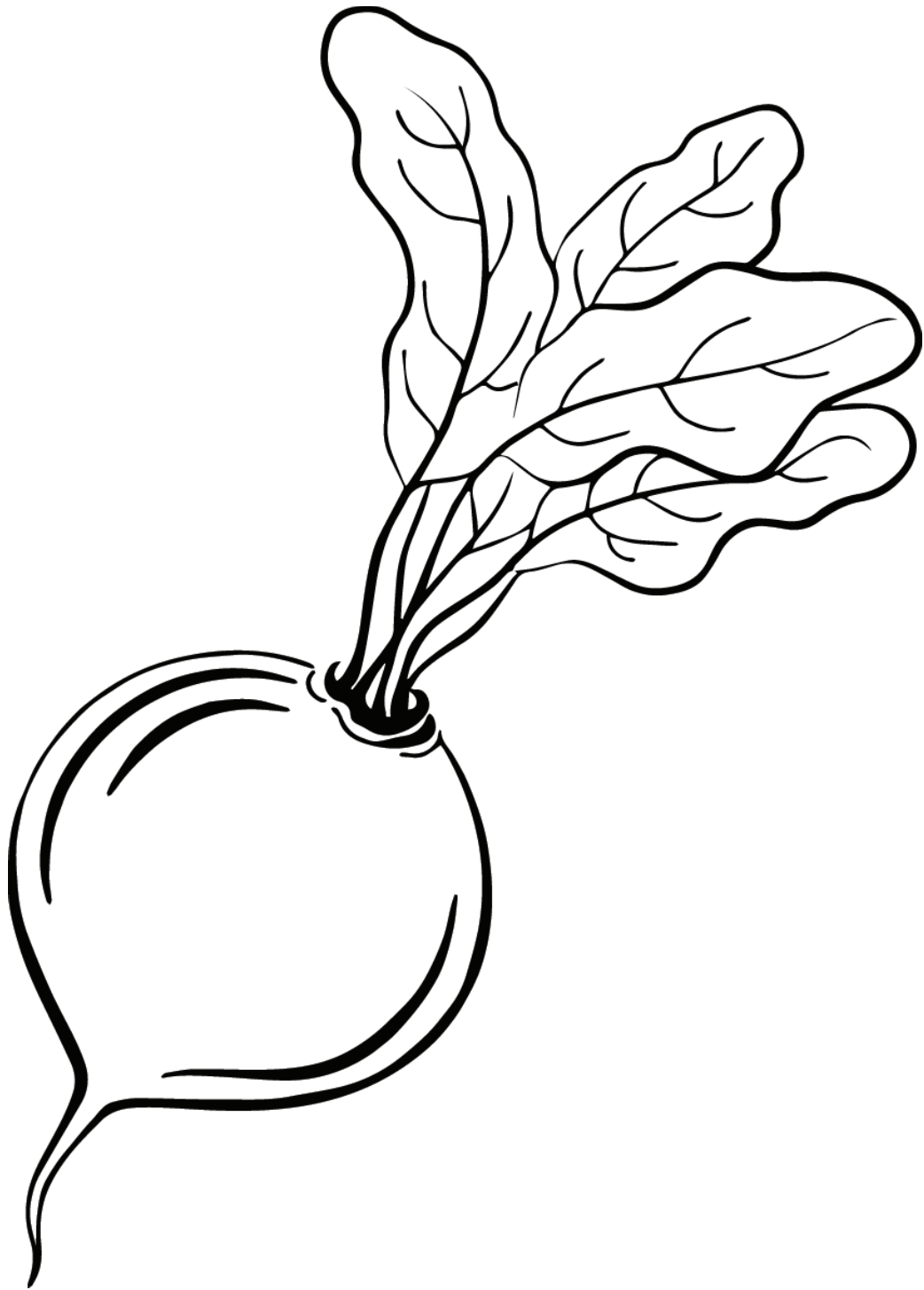

beetroot



giant

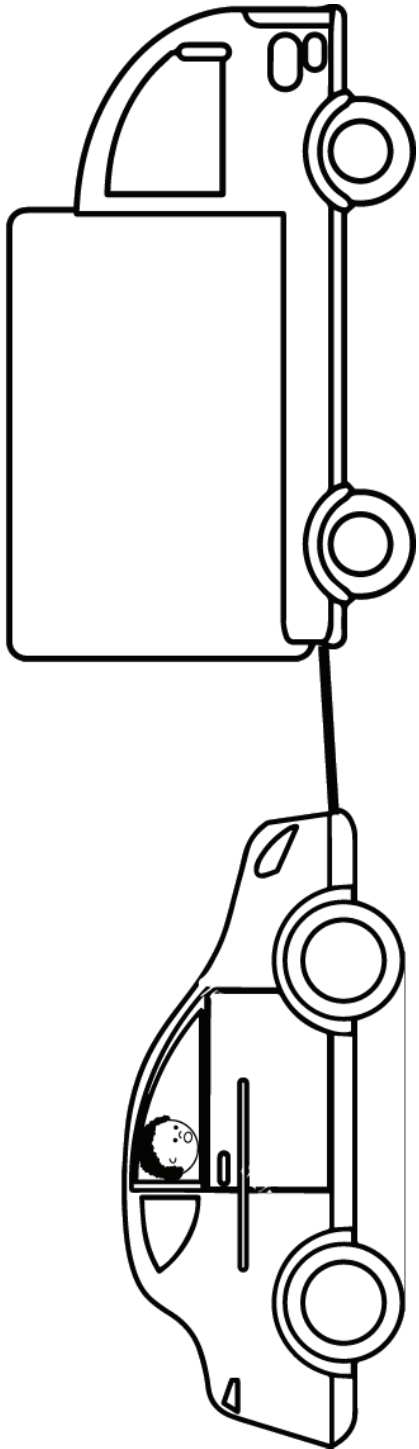

pull



stuck

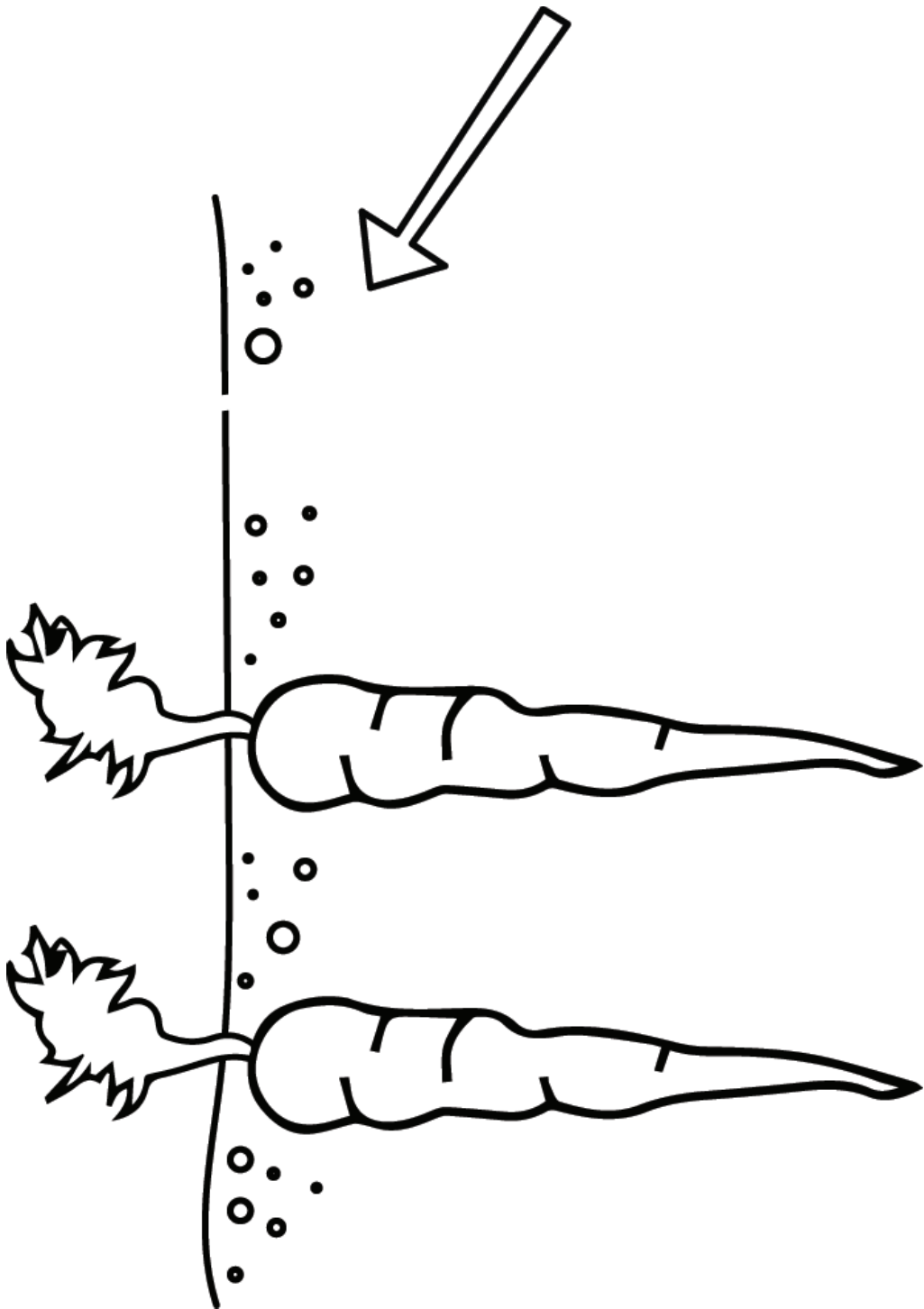

ground

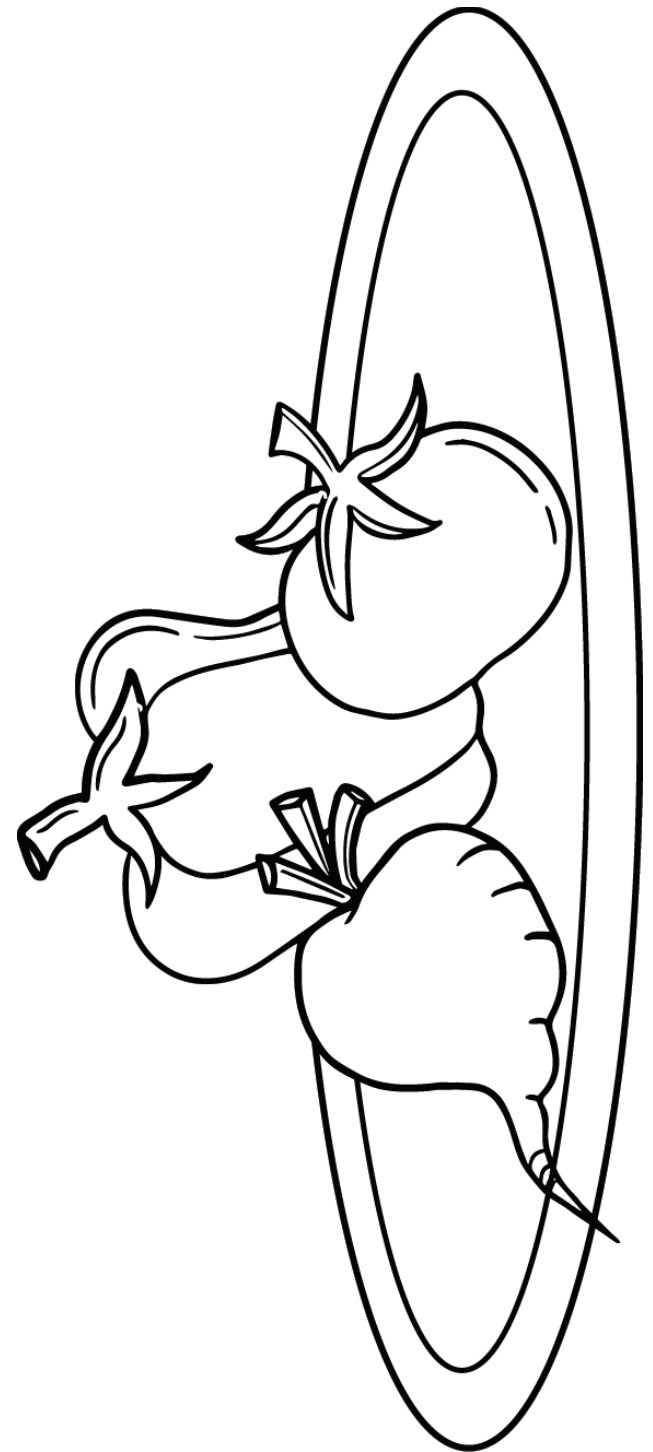

vegetables



sweaty

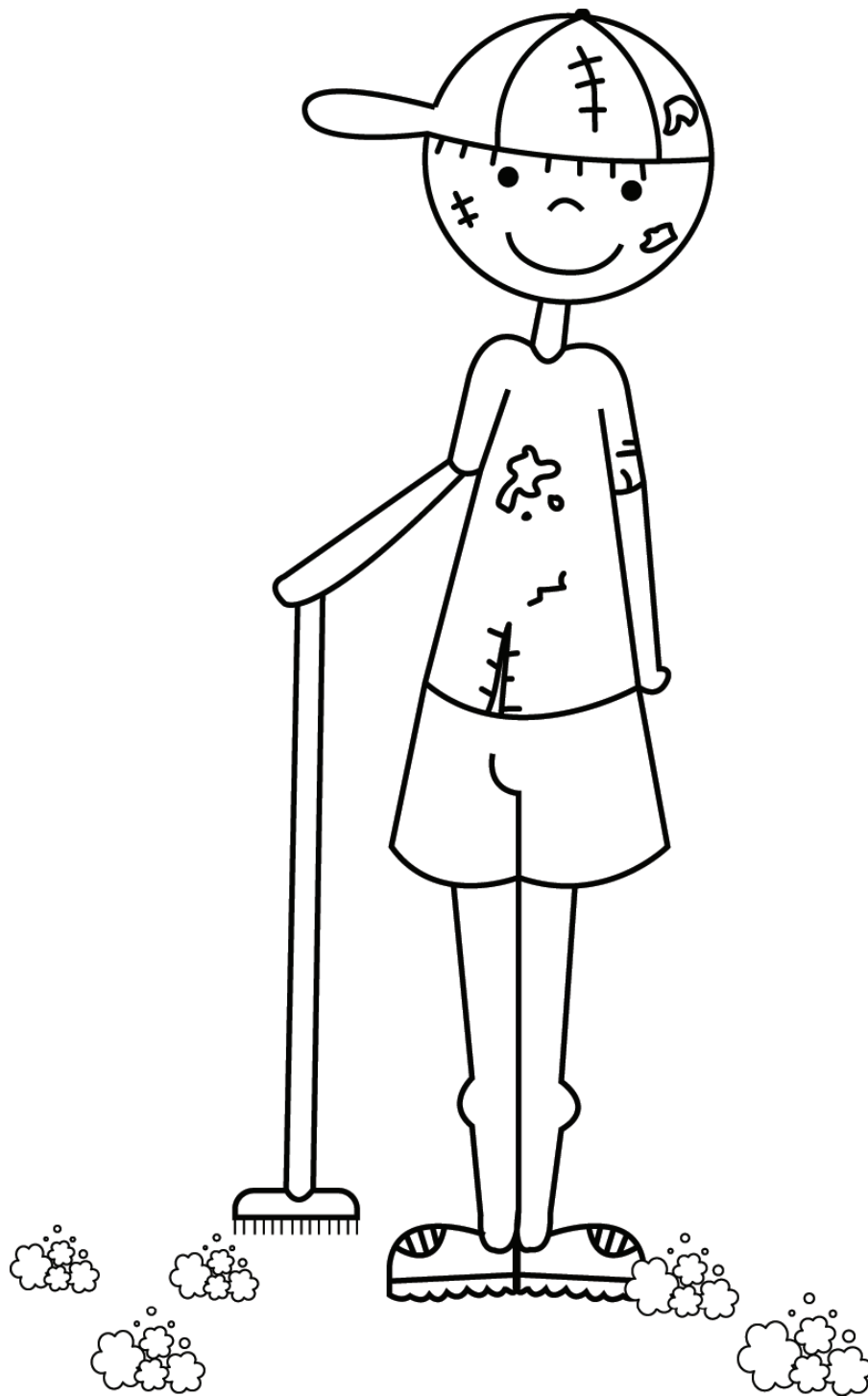

dirty

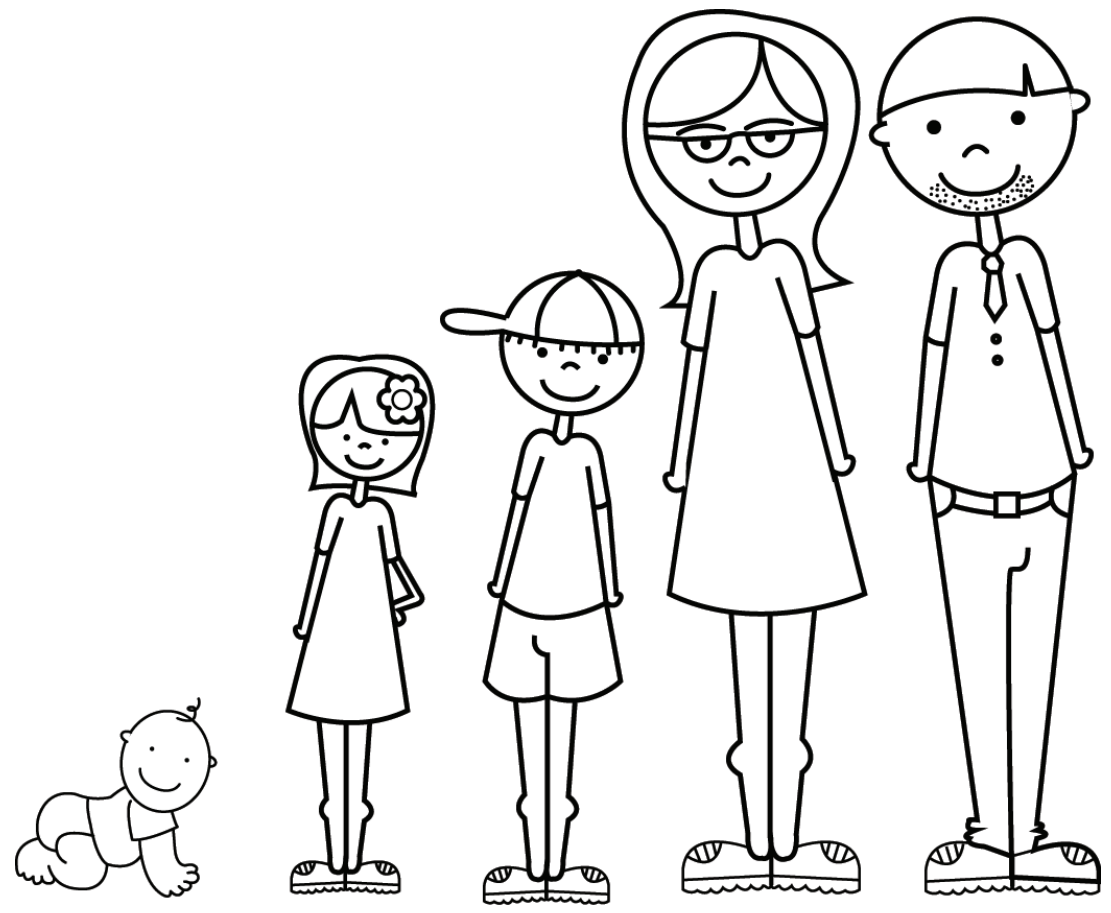

family

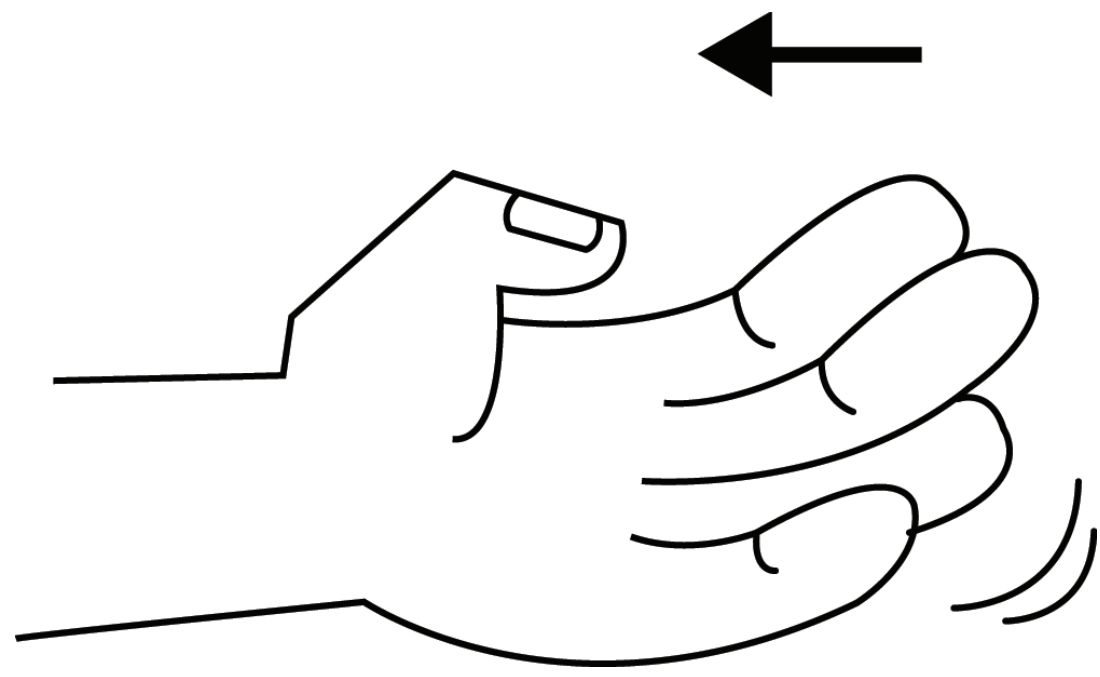

call



clever

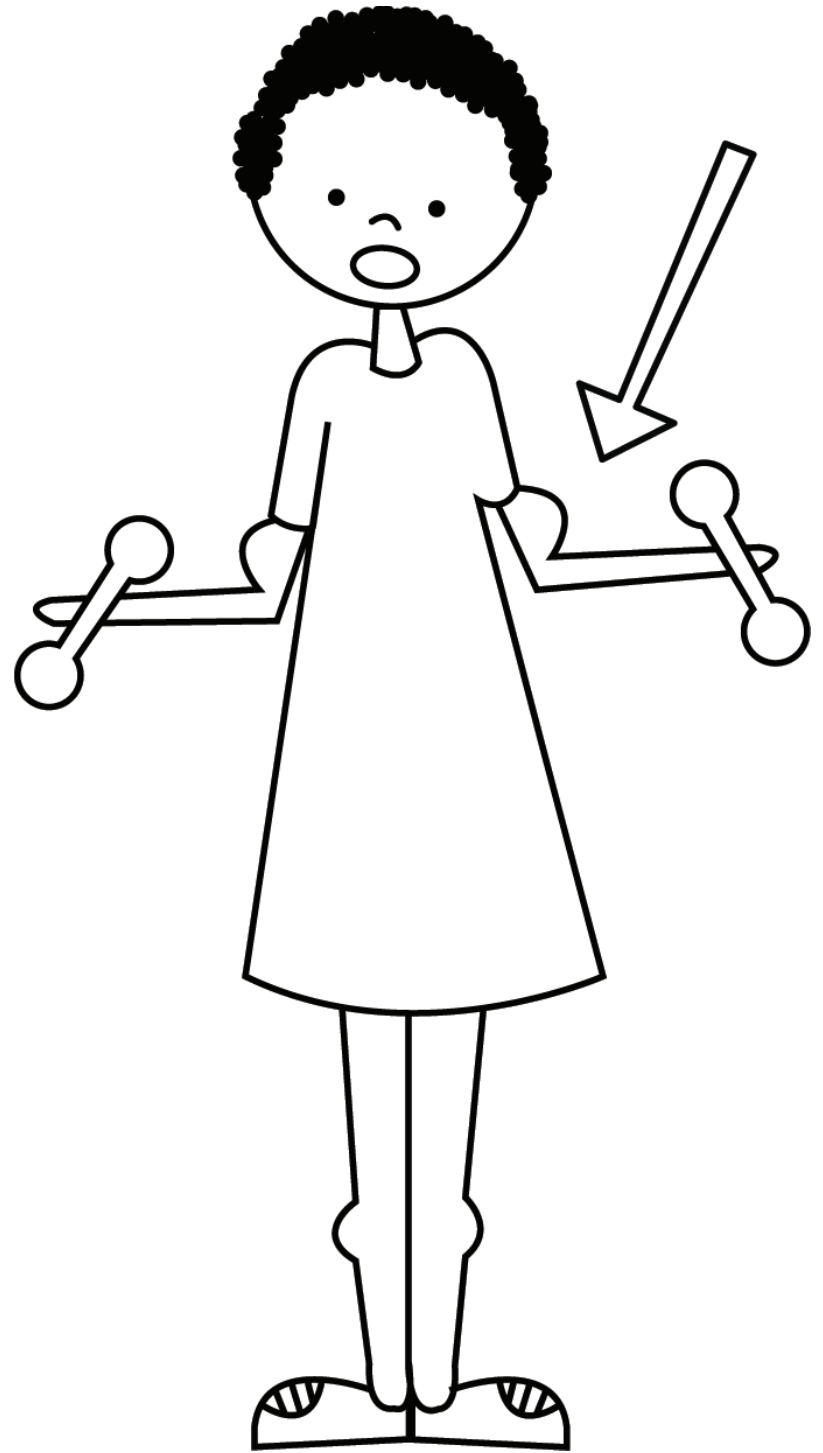

strong

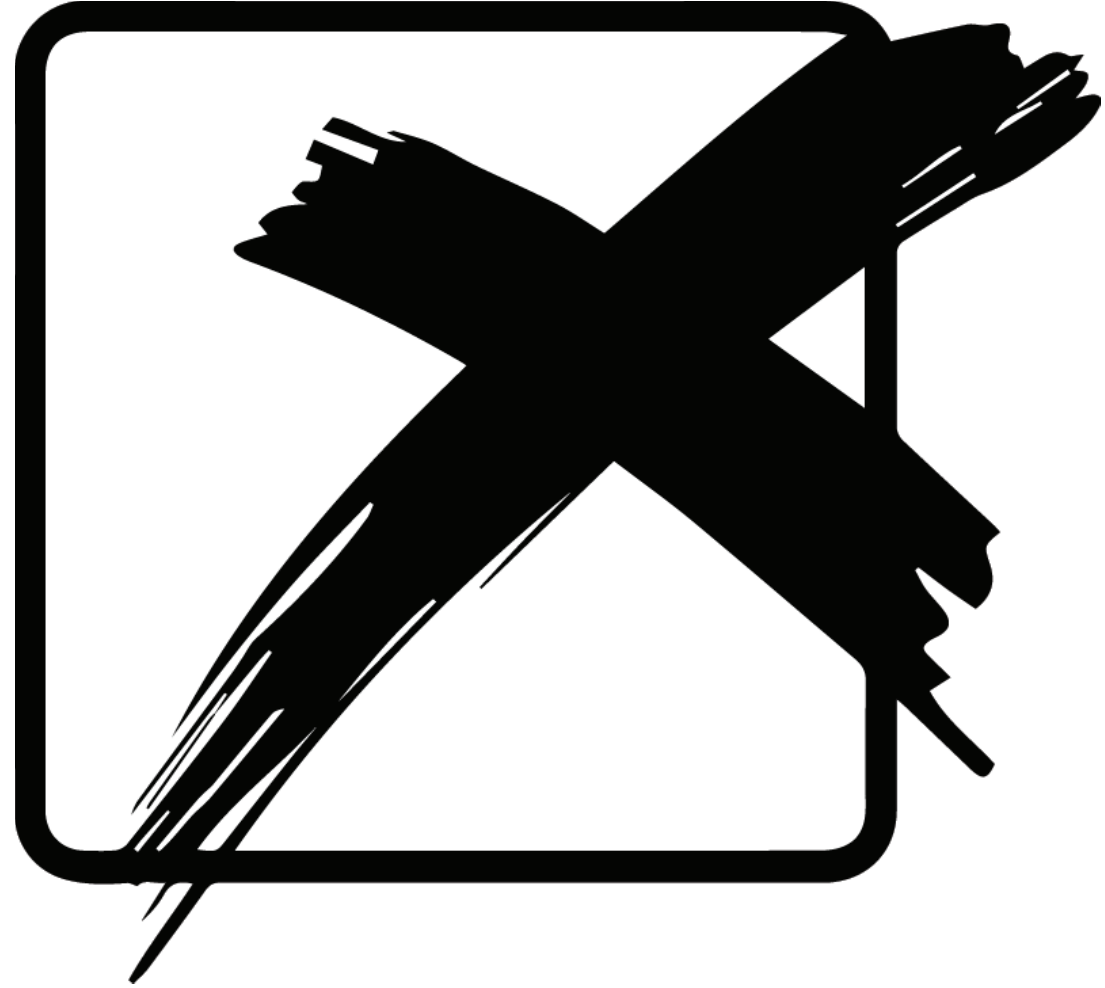

wrong



right

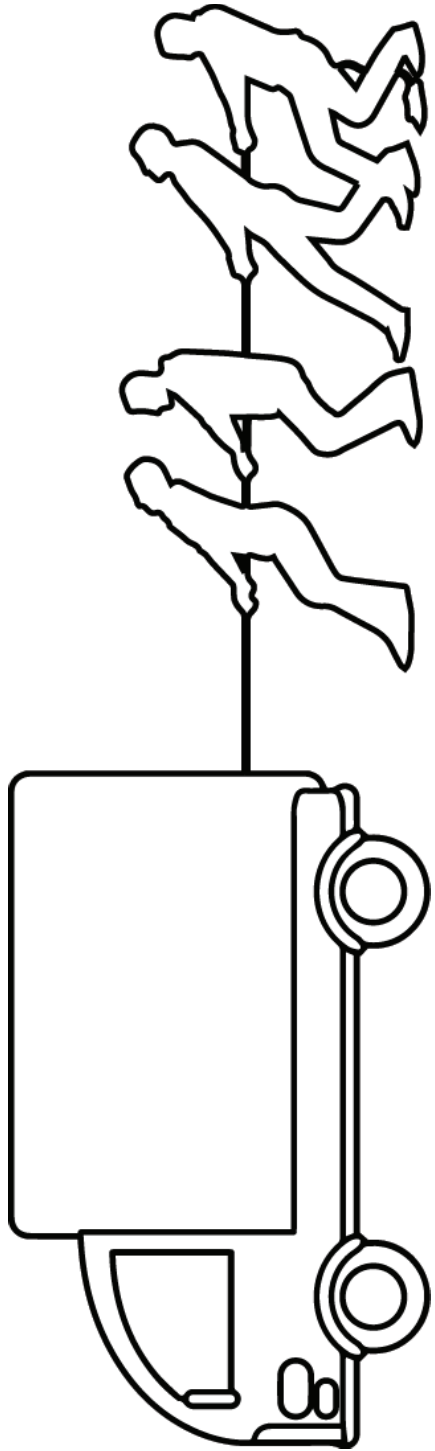

teamwork

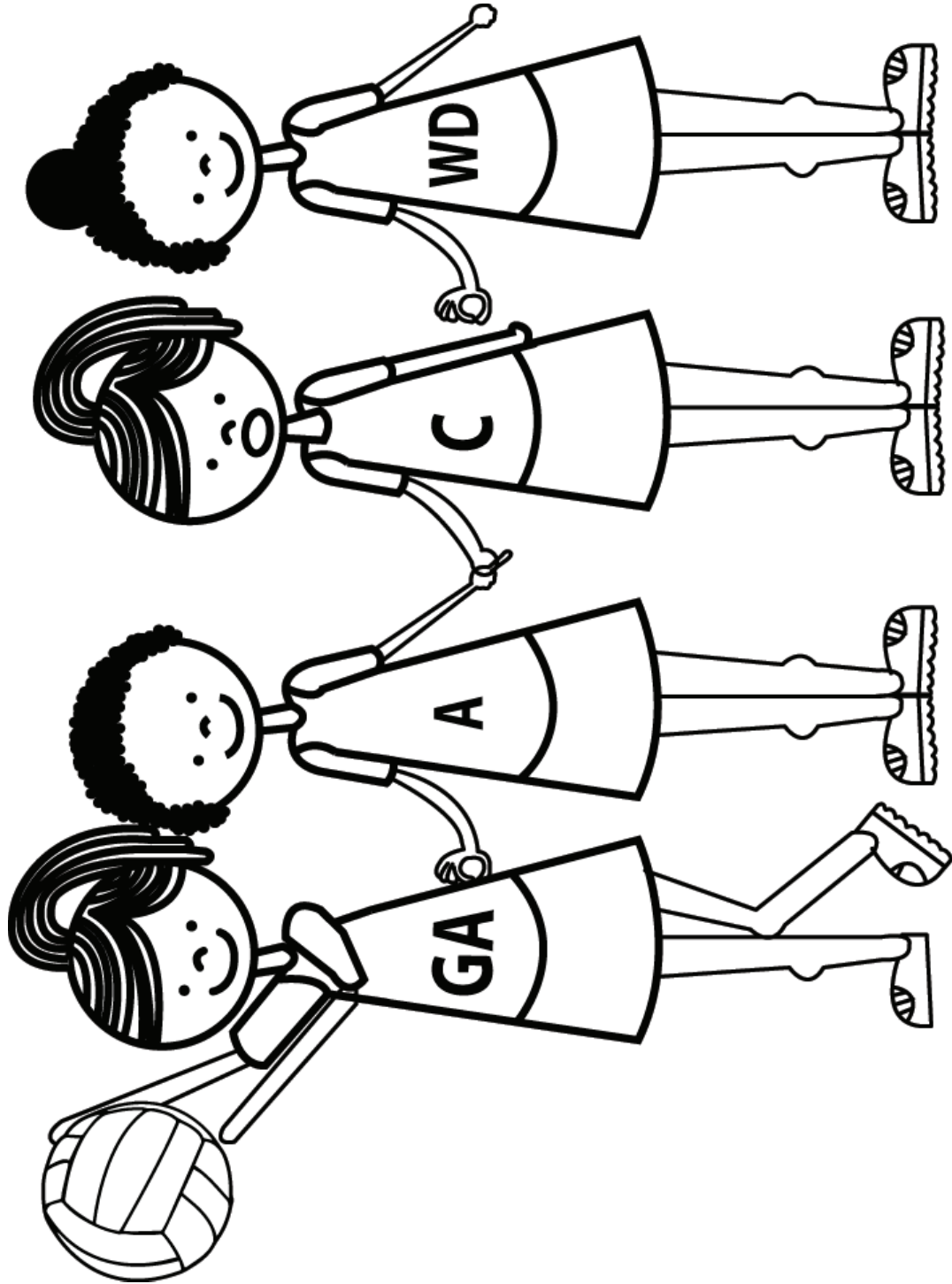

team

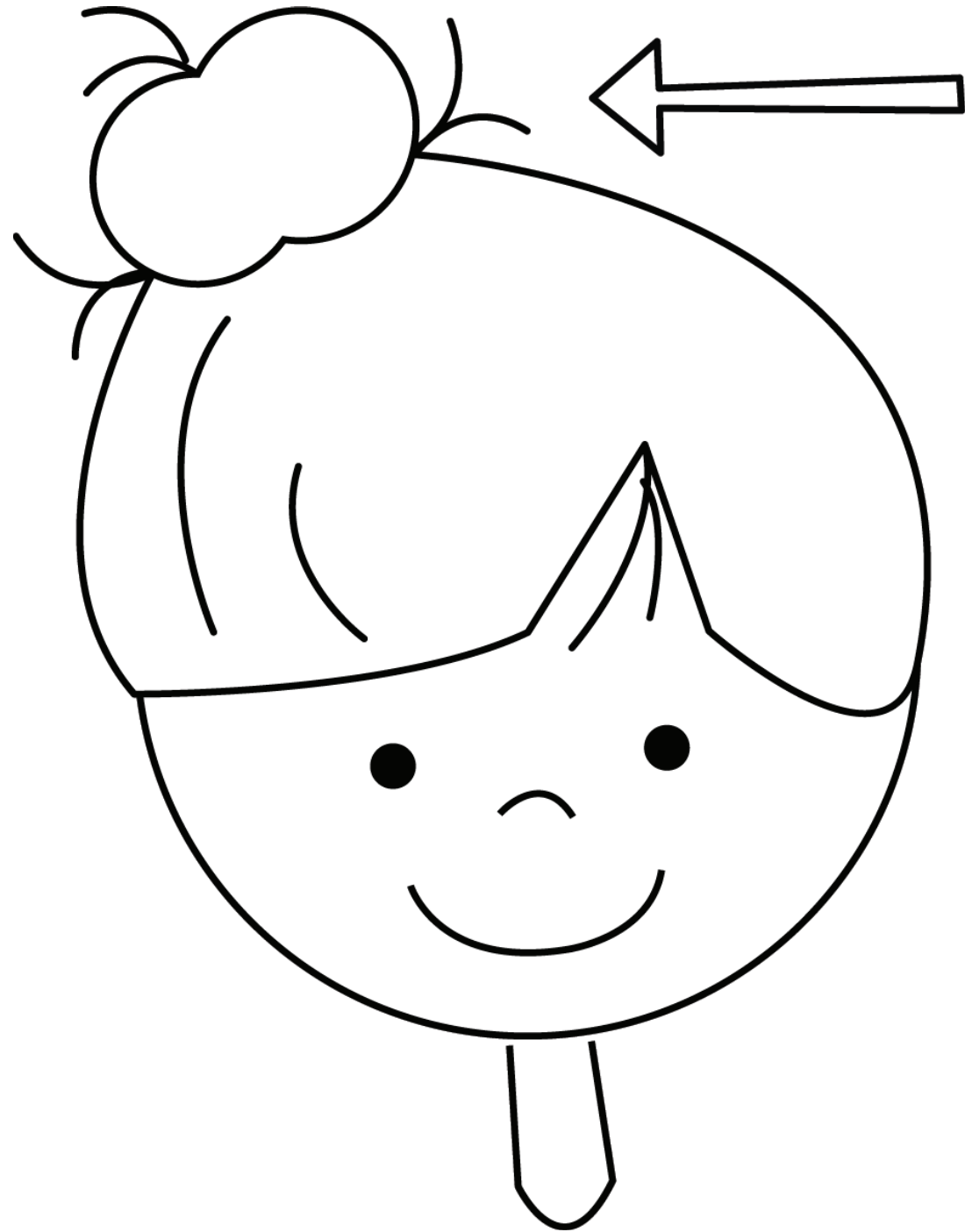

messy

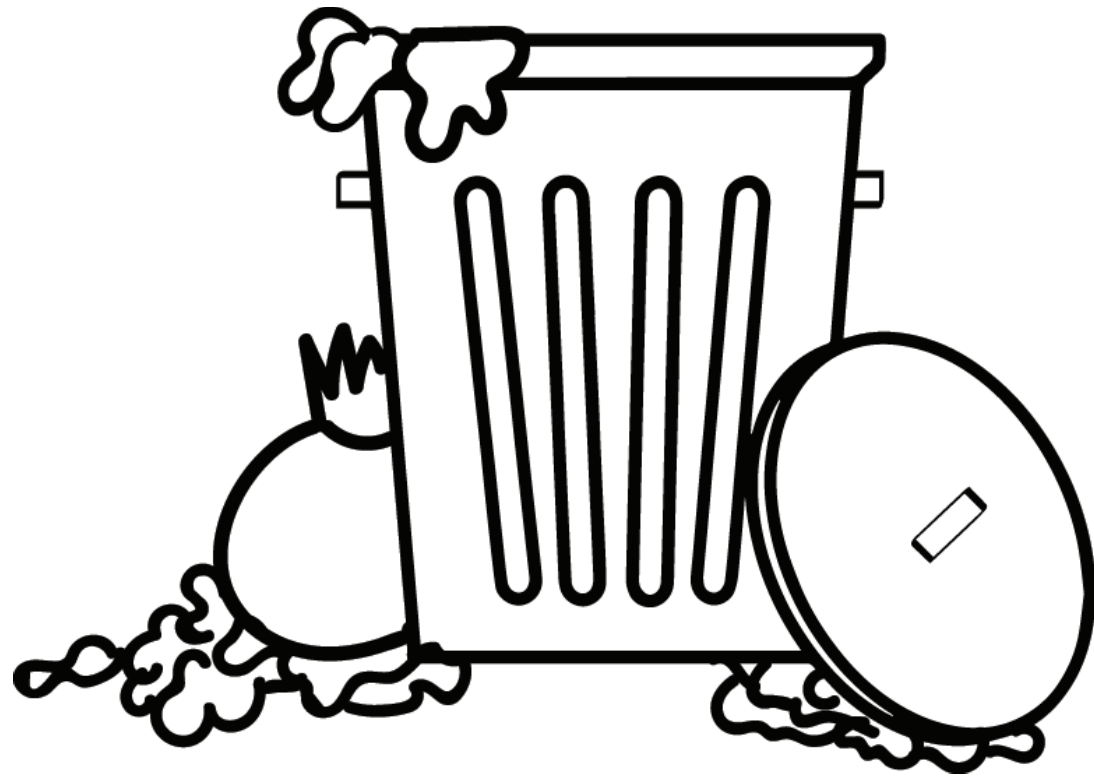

mess



clean

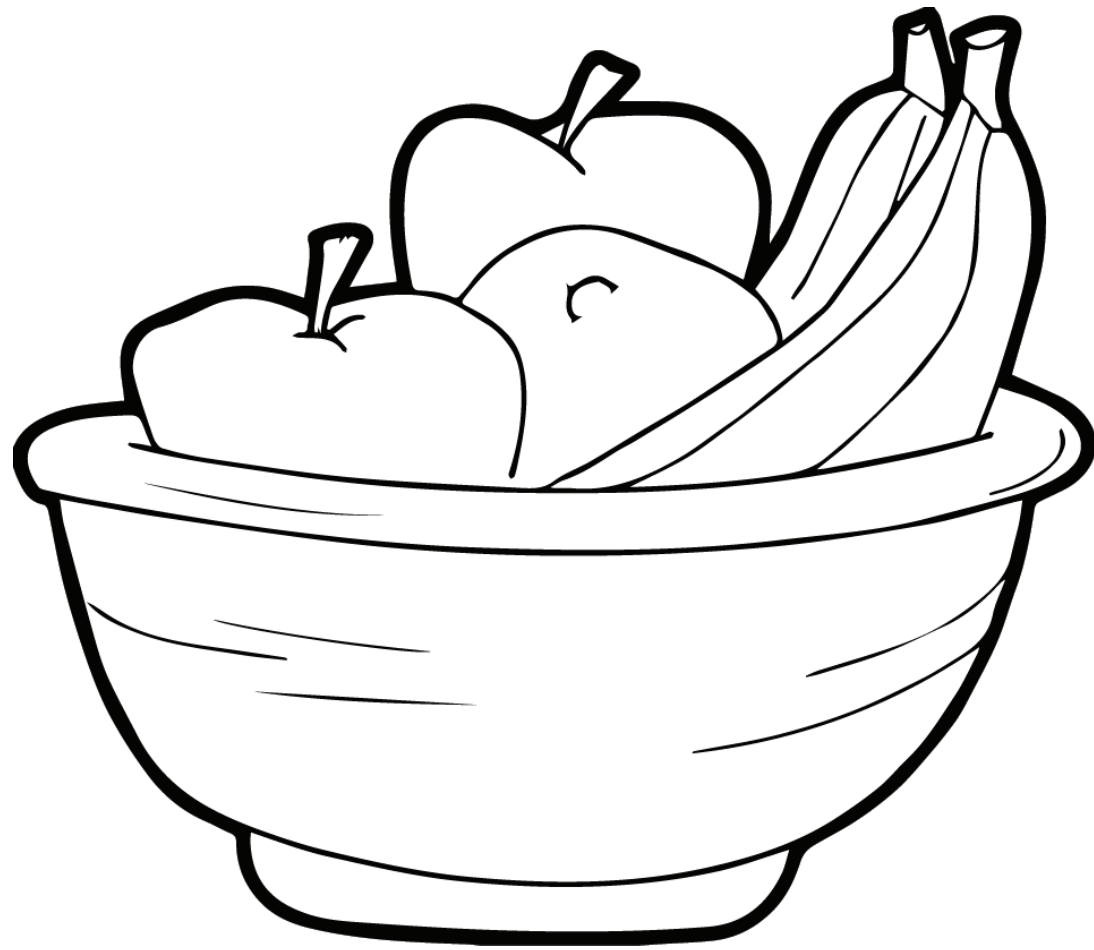

fruit

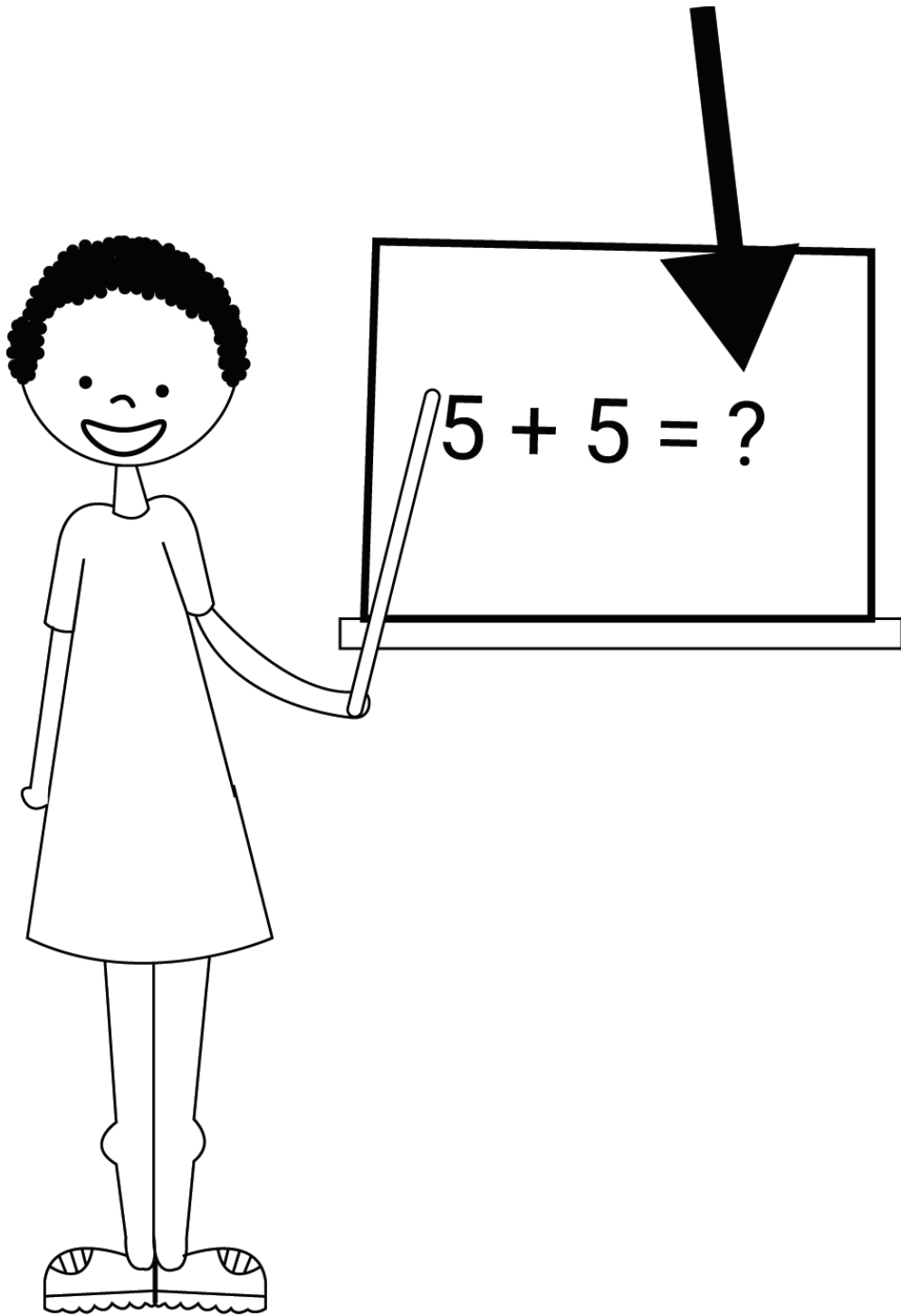

problem



job

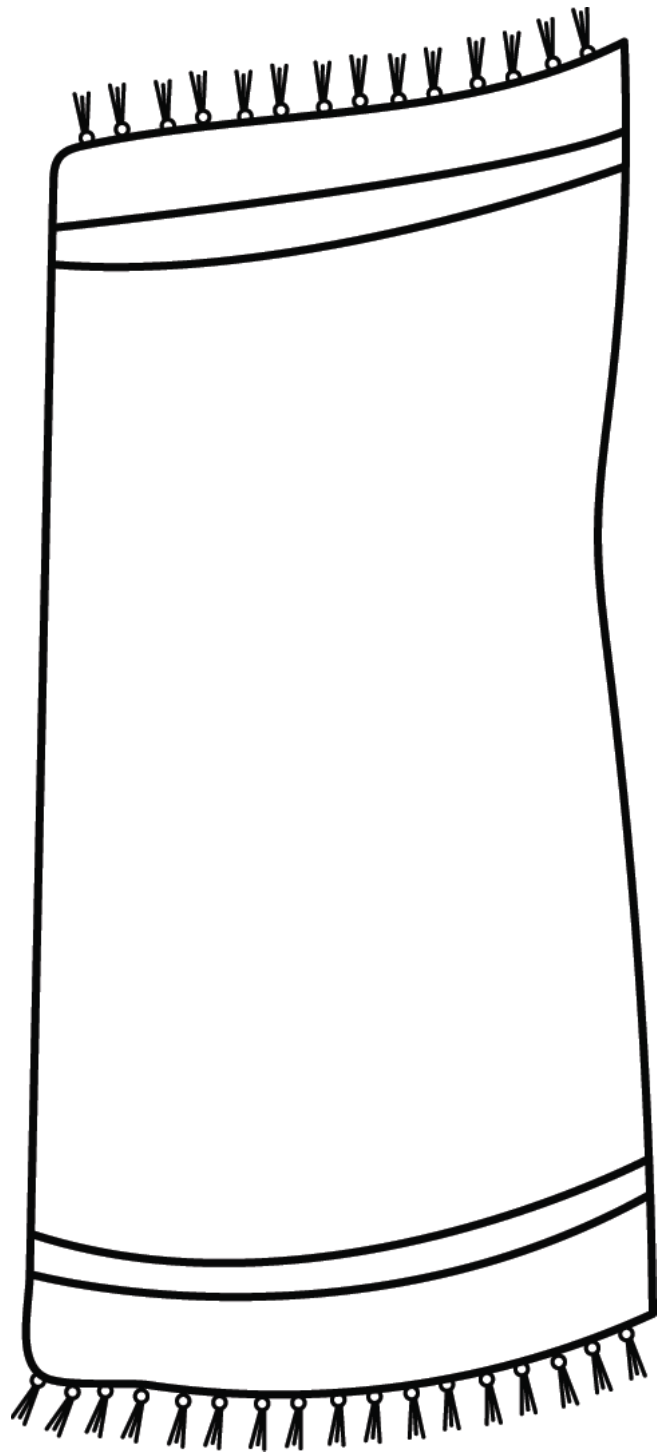

carpet



scrub

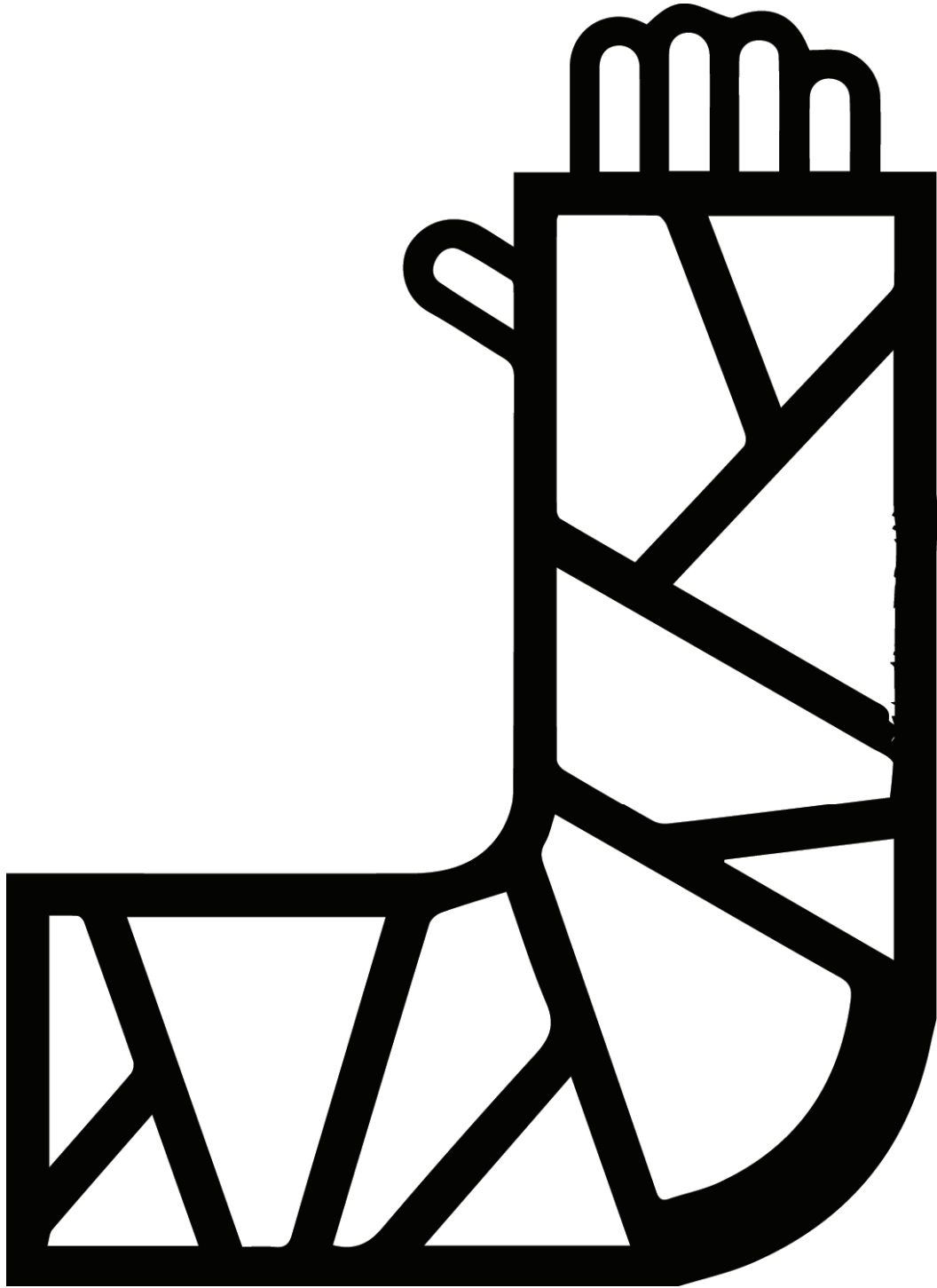

broken

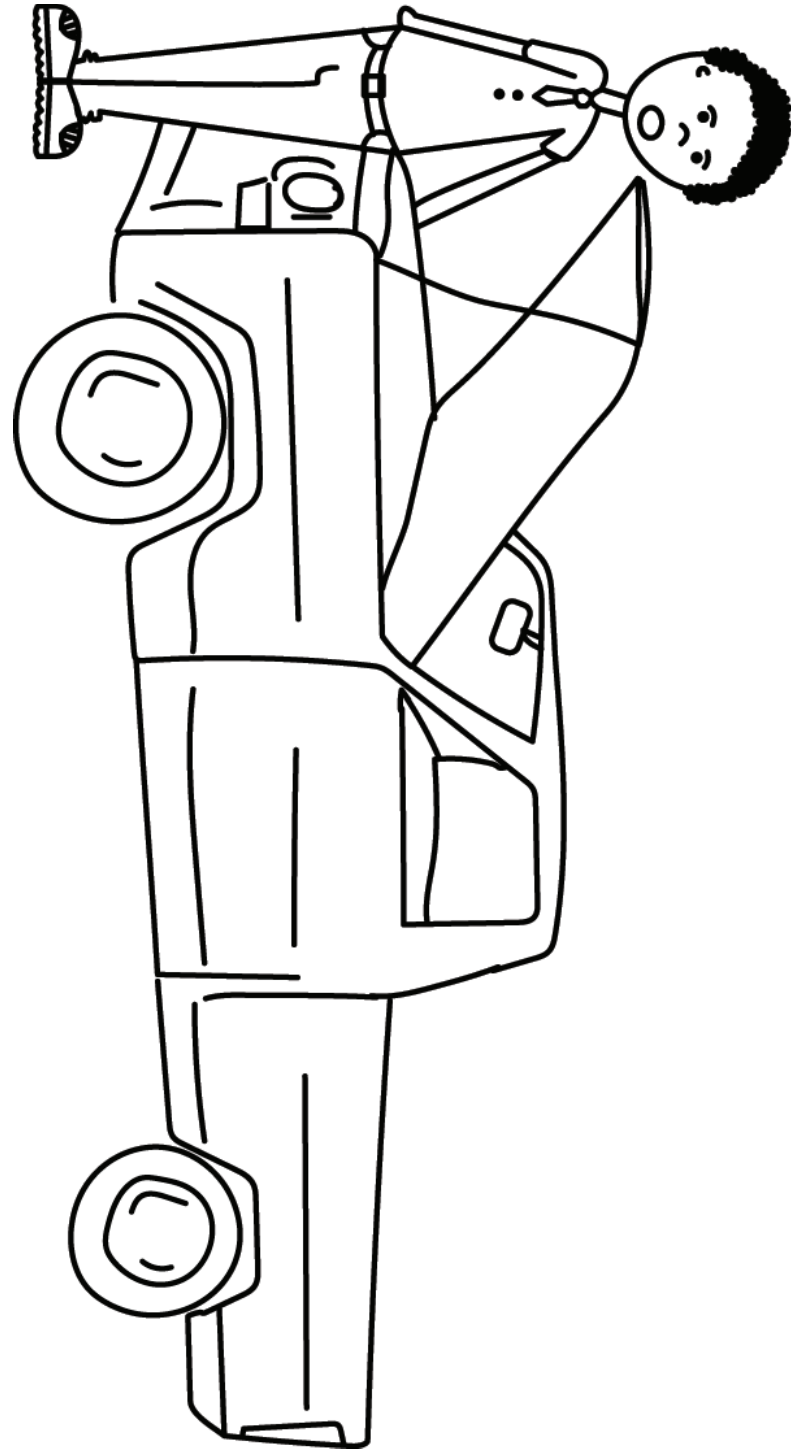

fix

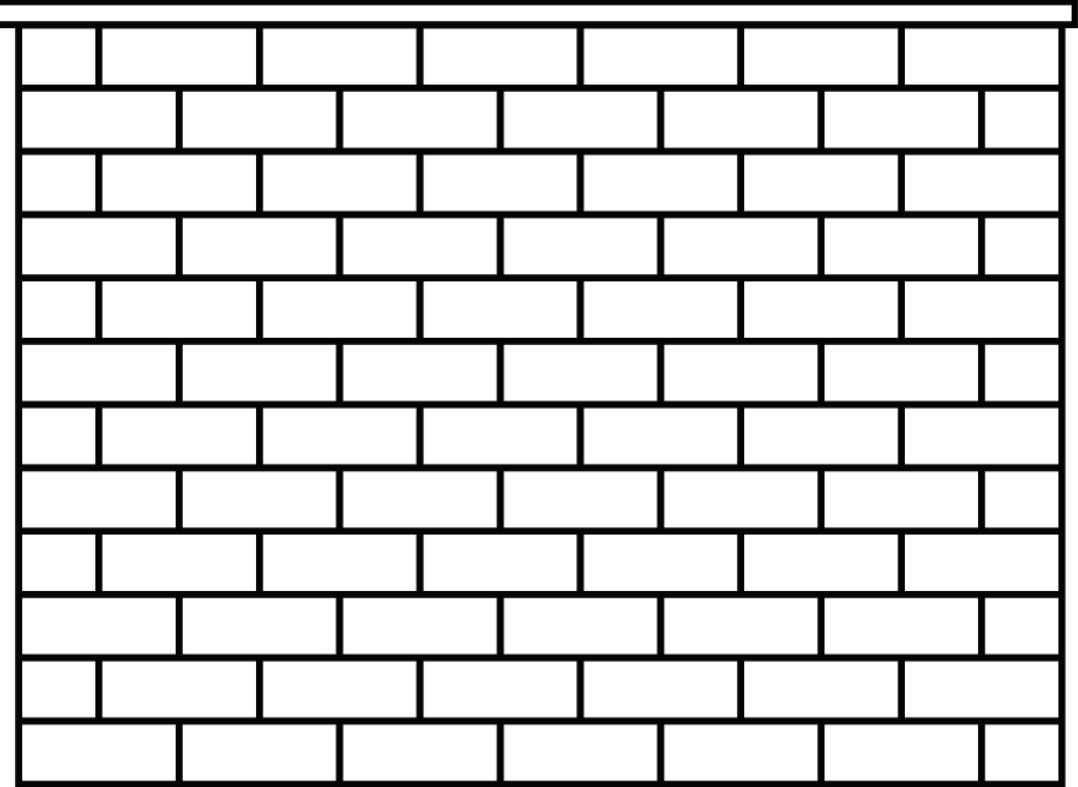

wall

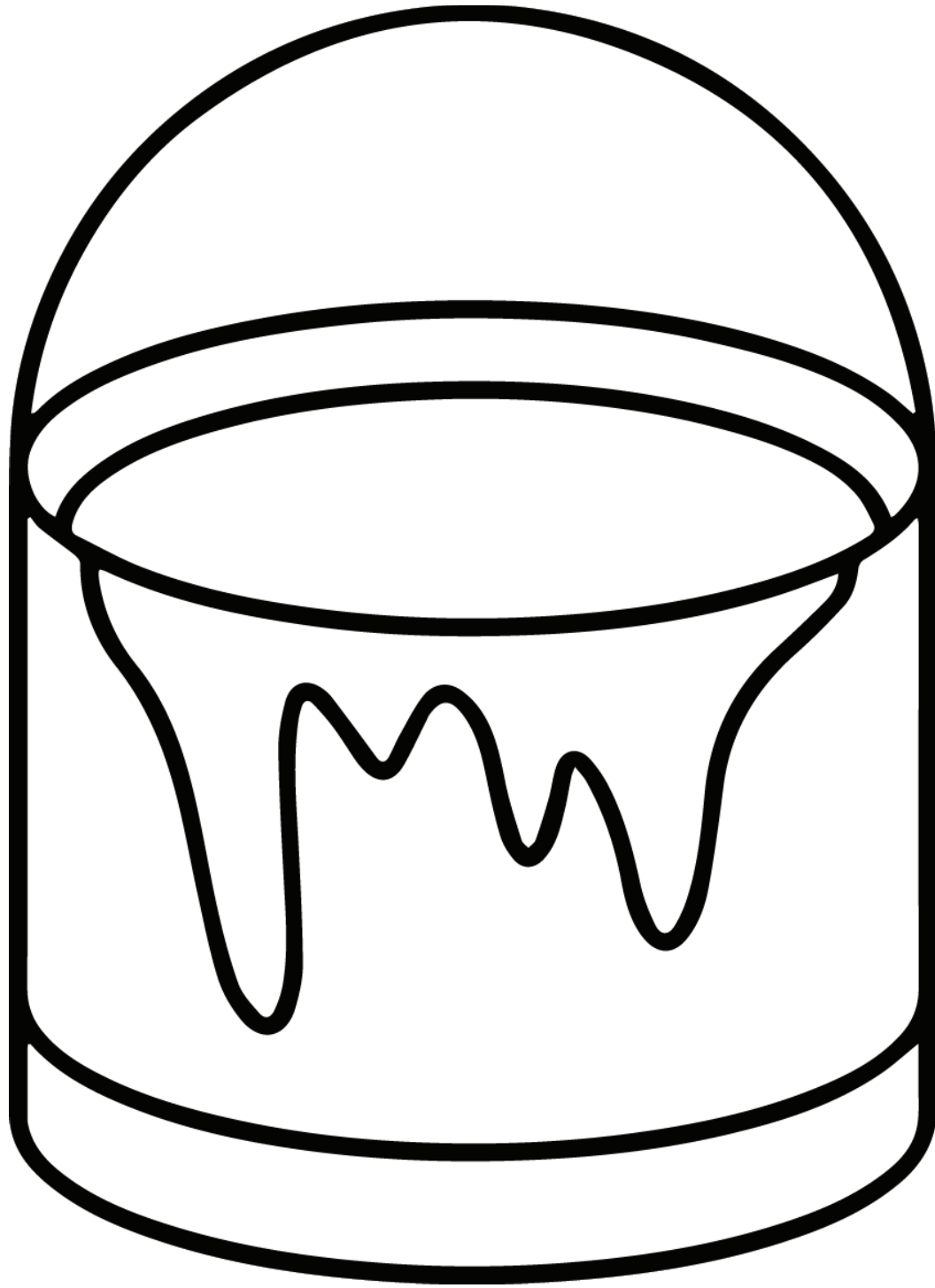

paint

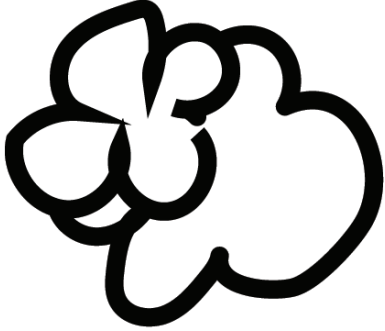
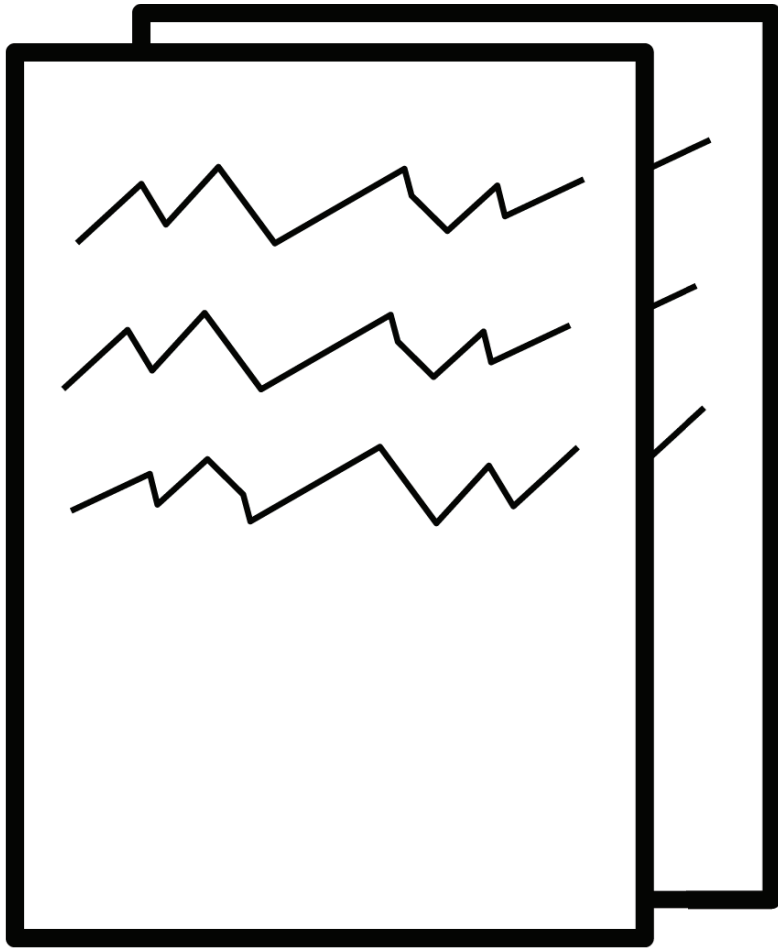

papers



pile

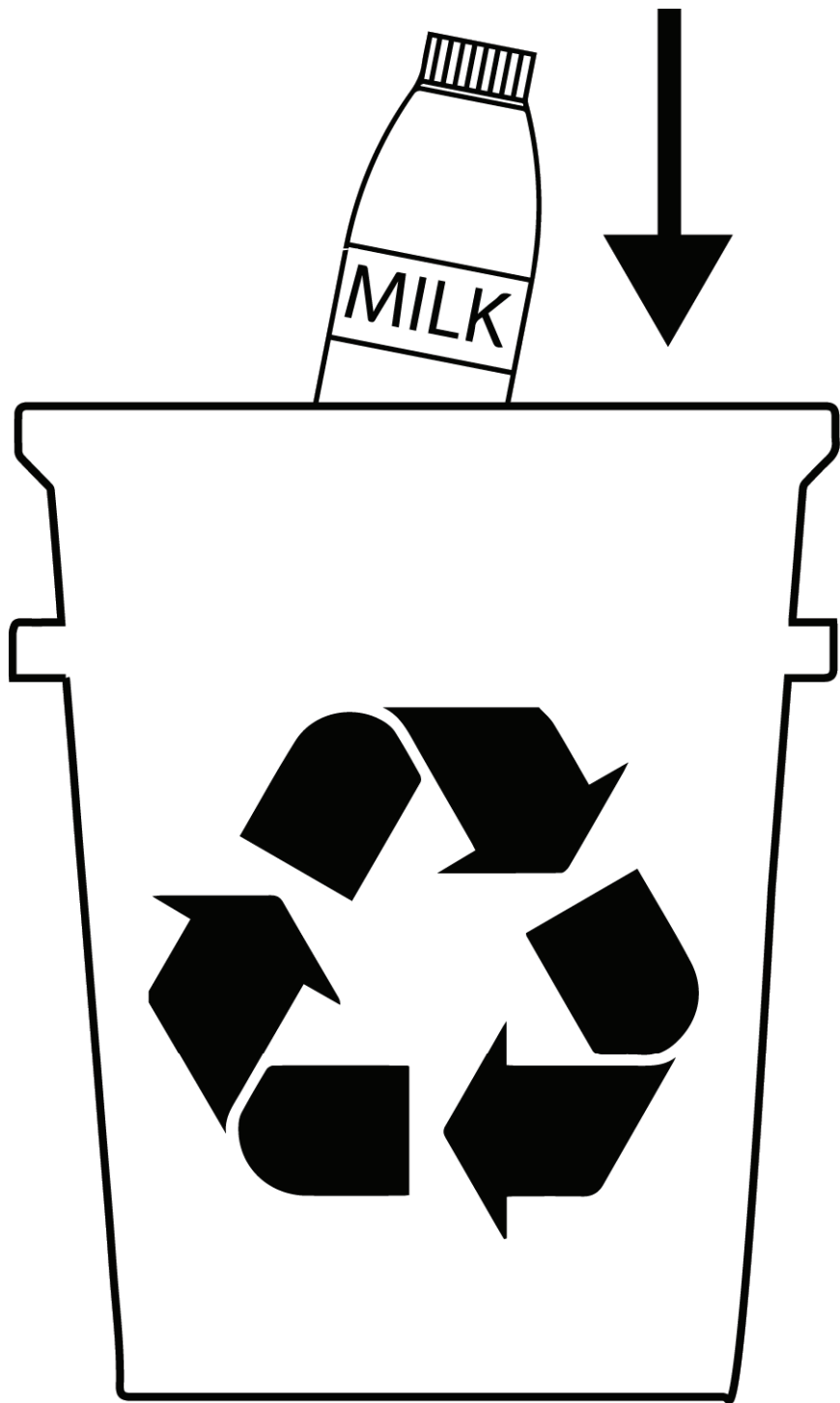

recycle

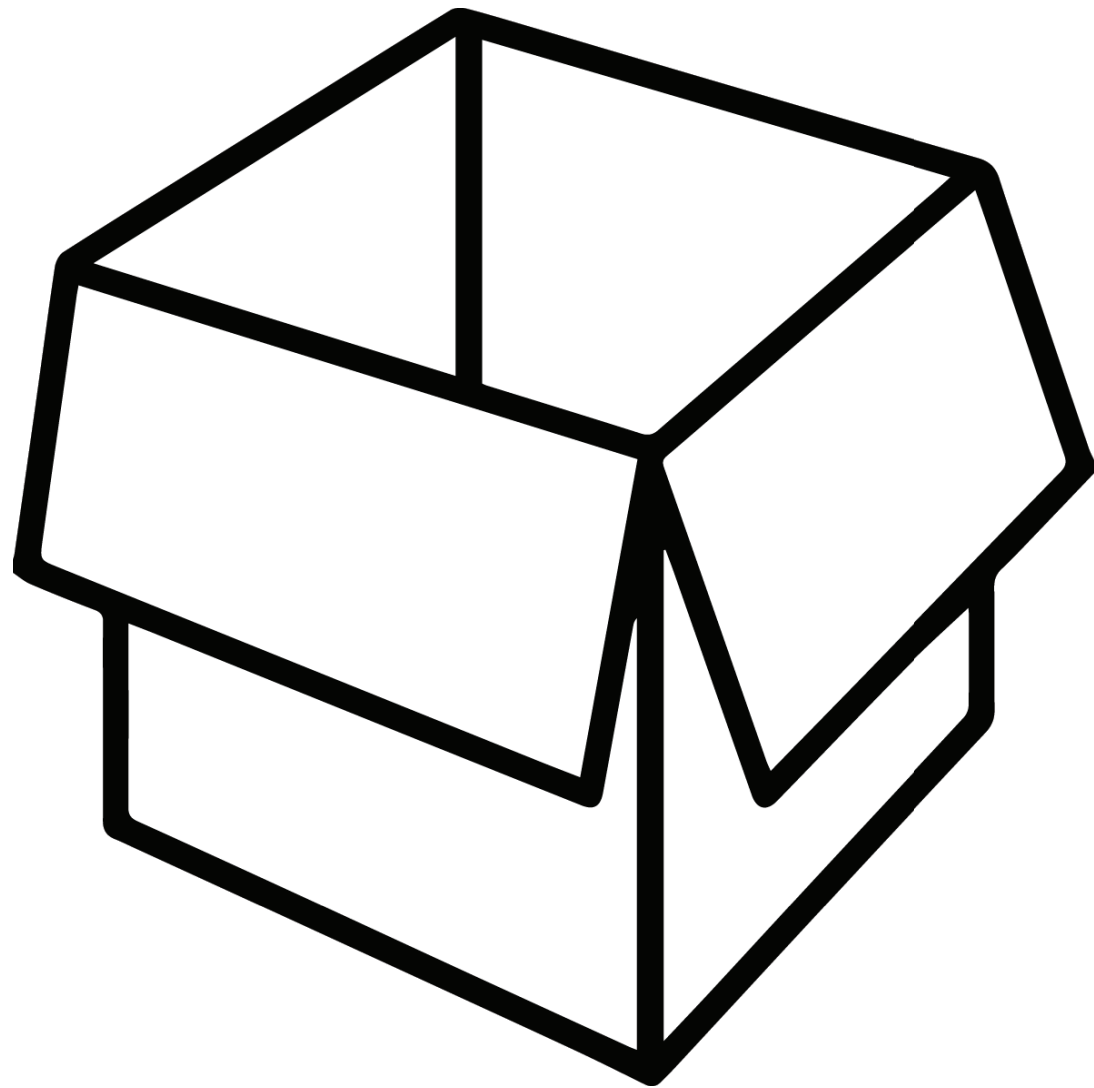

box

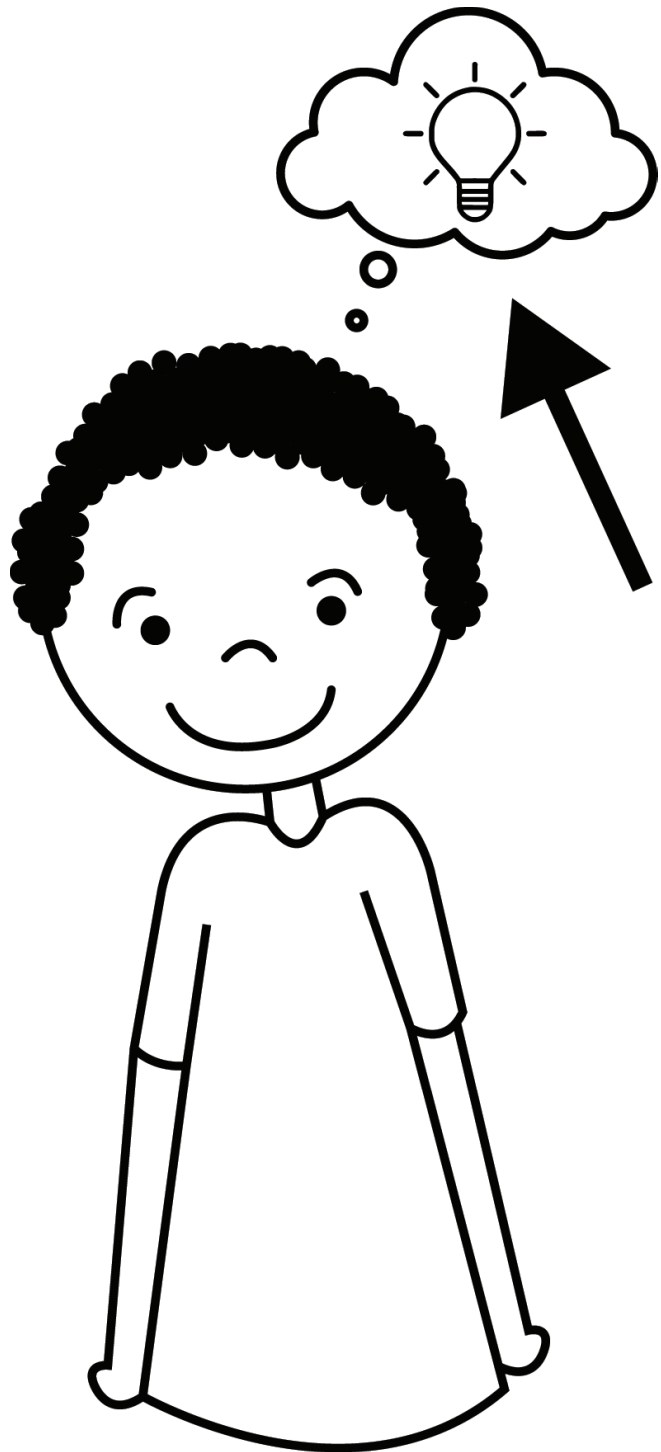

idea

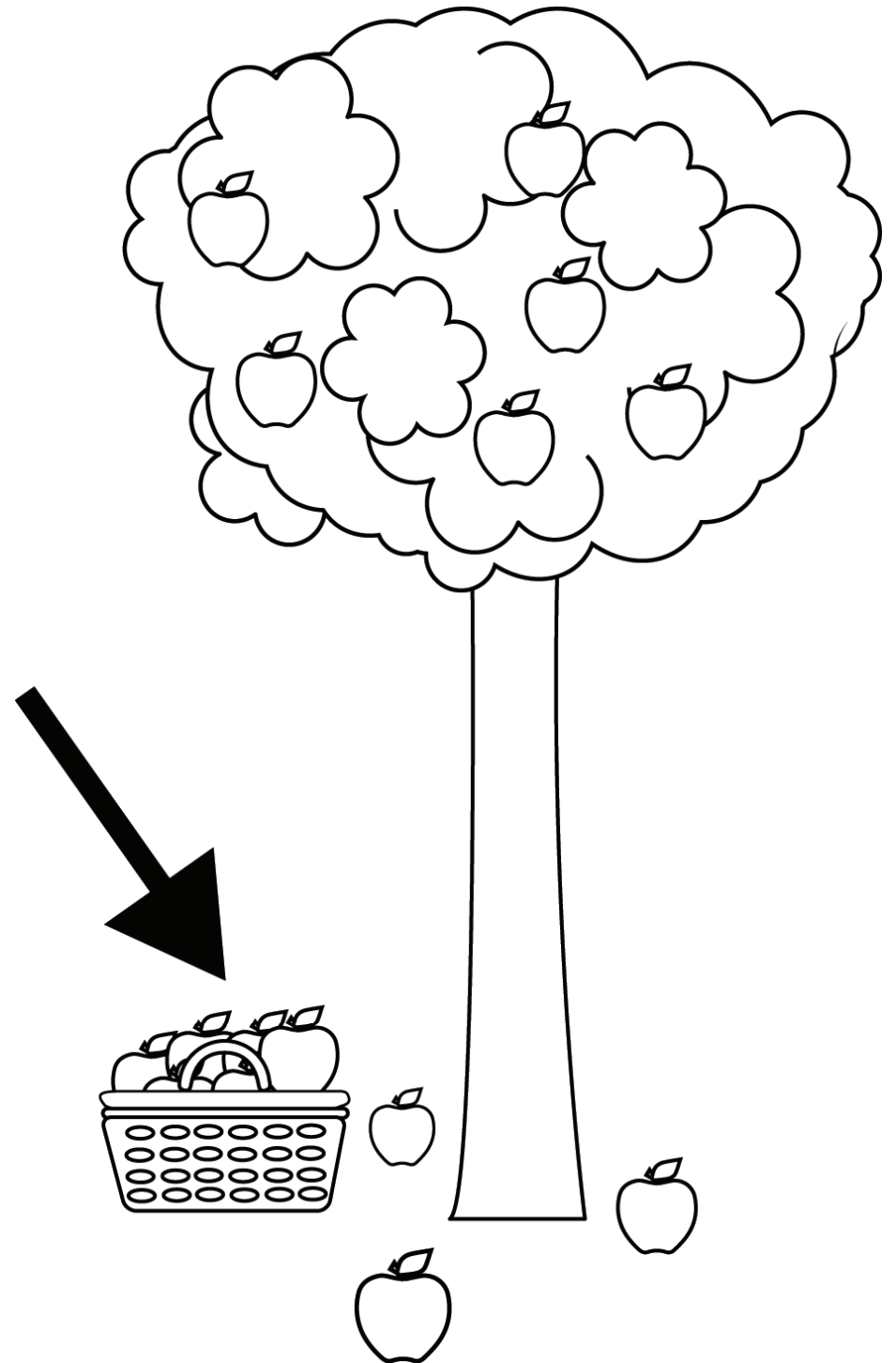

gather

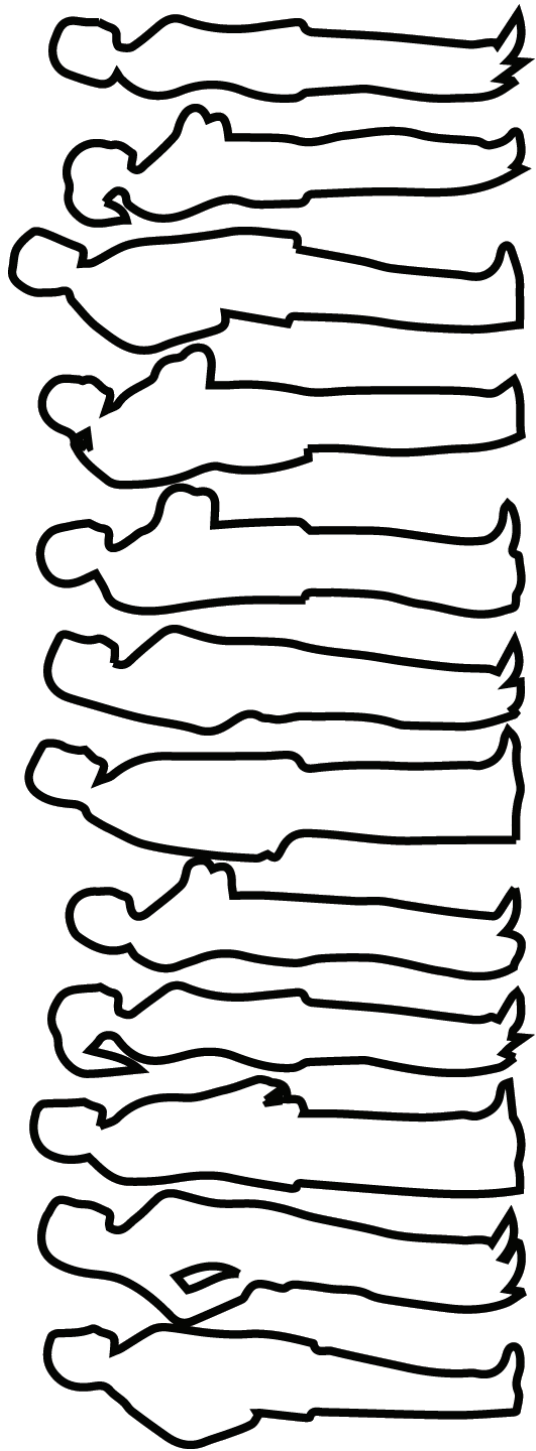

queue

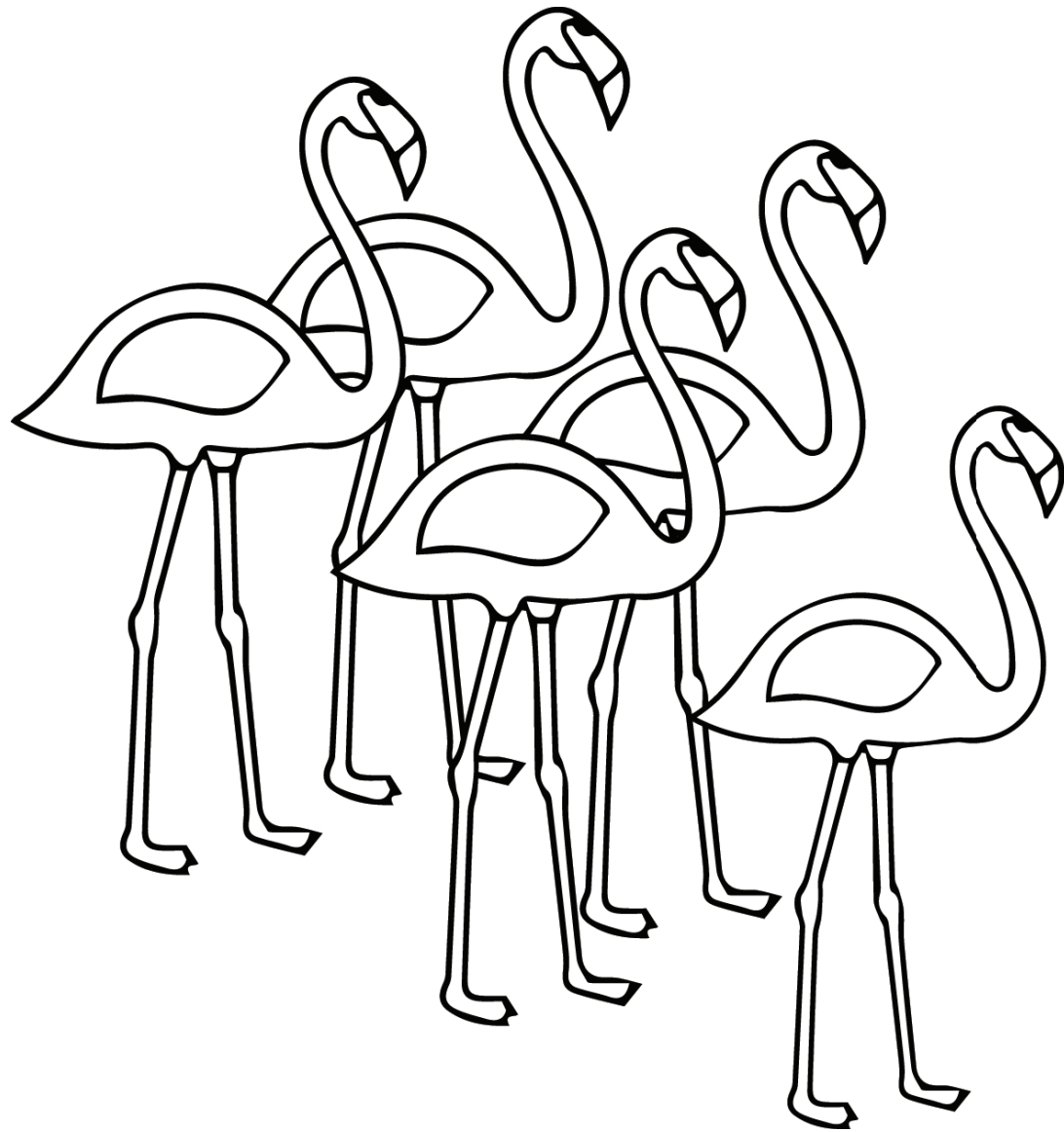

group

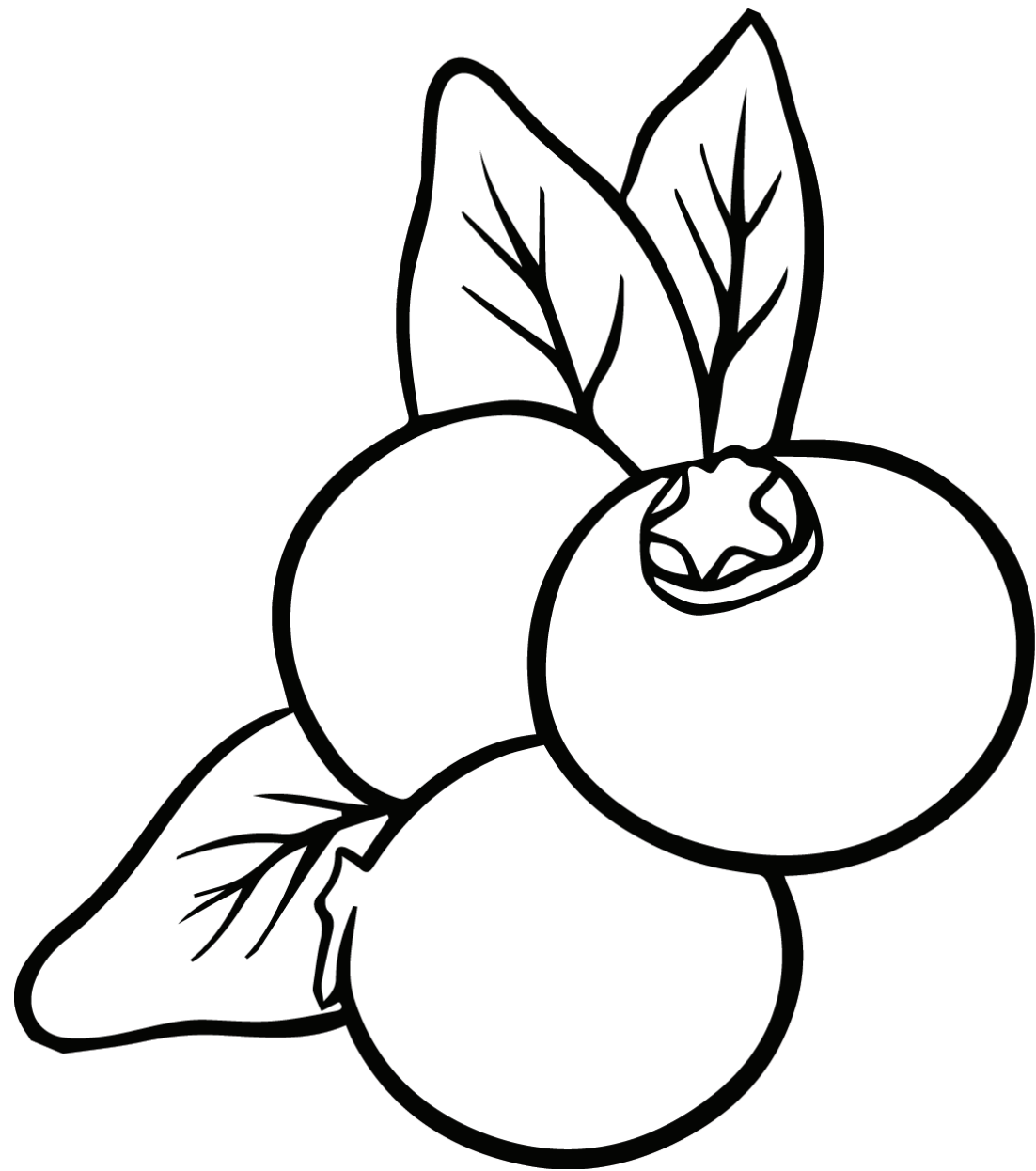

blue

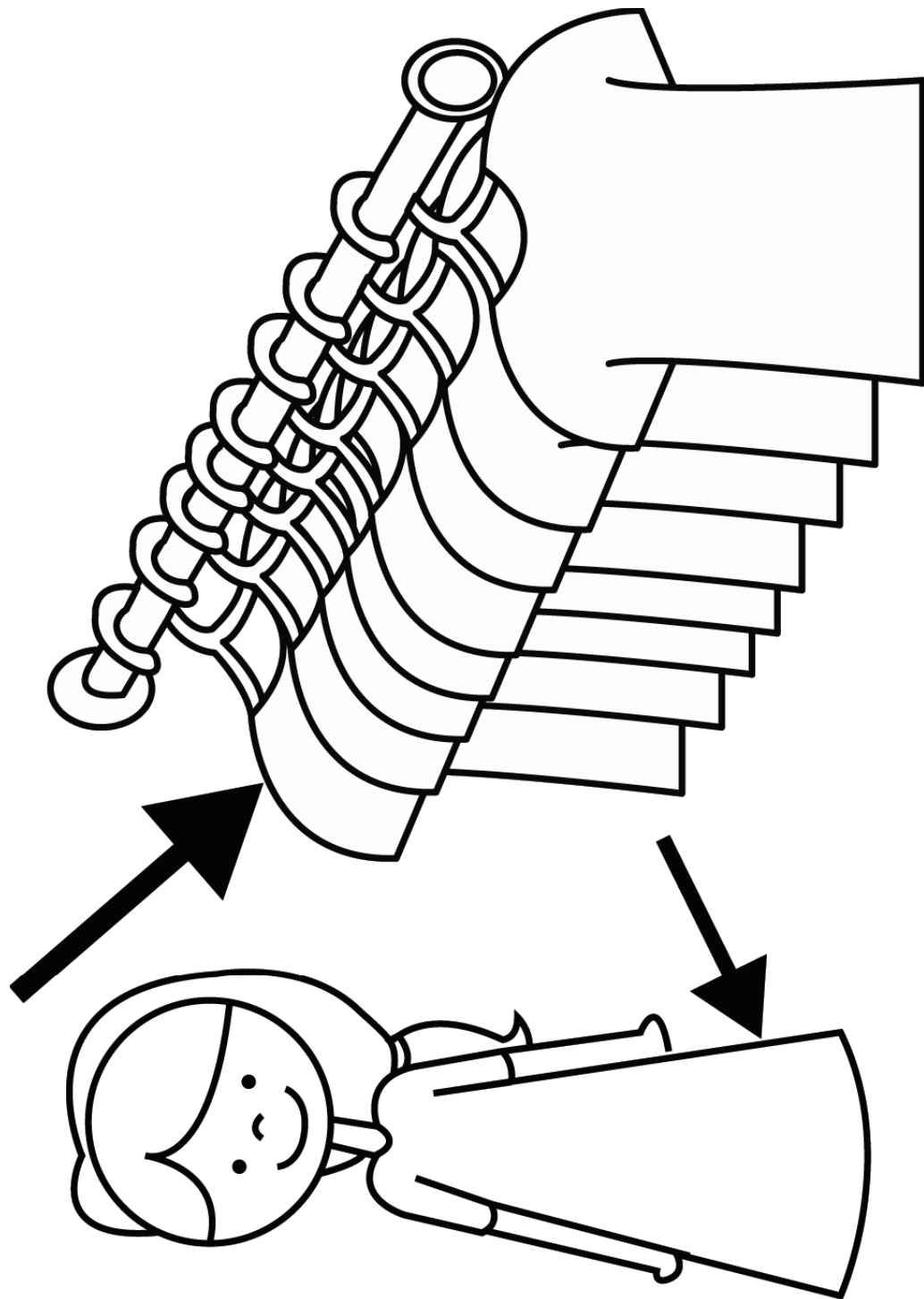

clothing

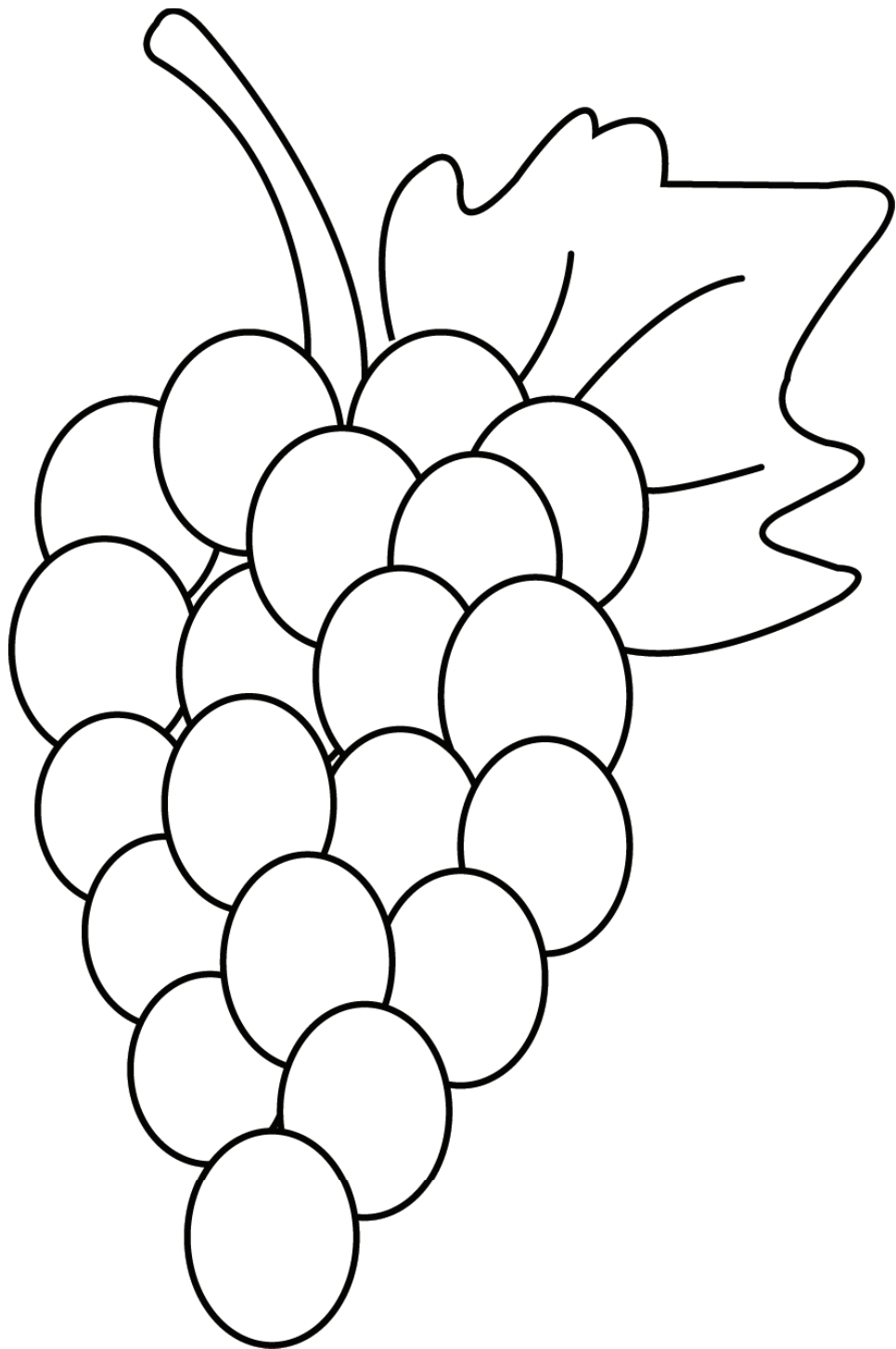

purple

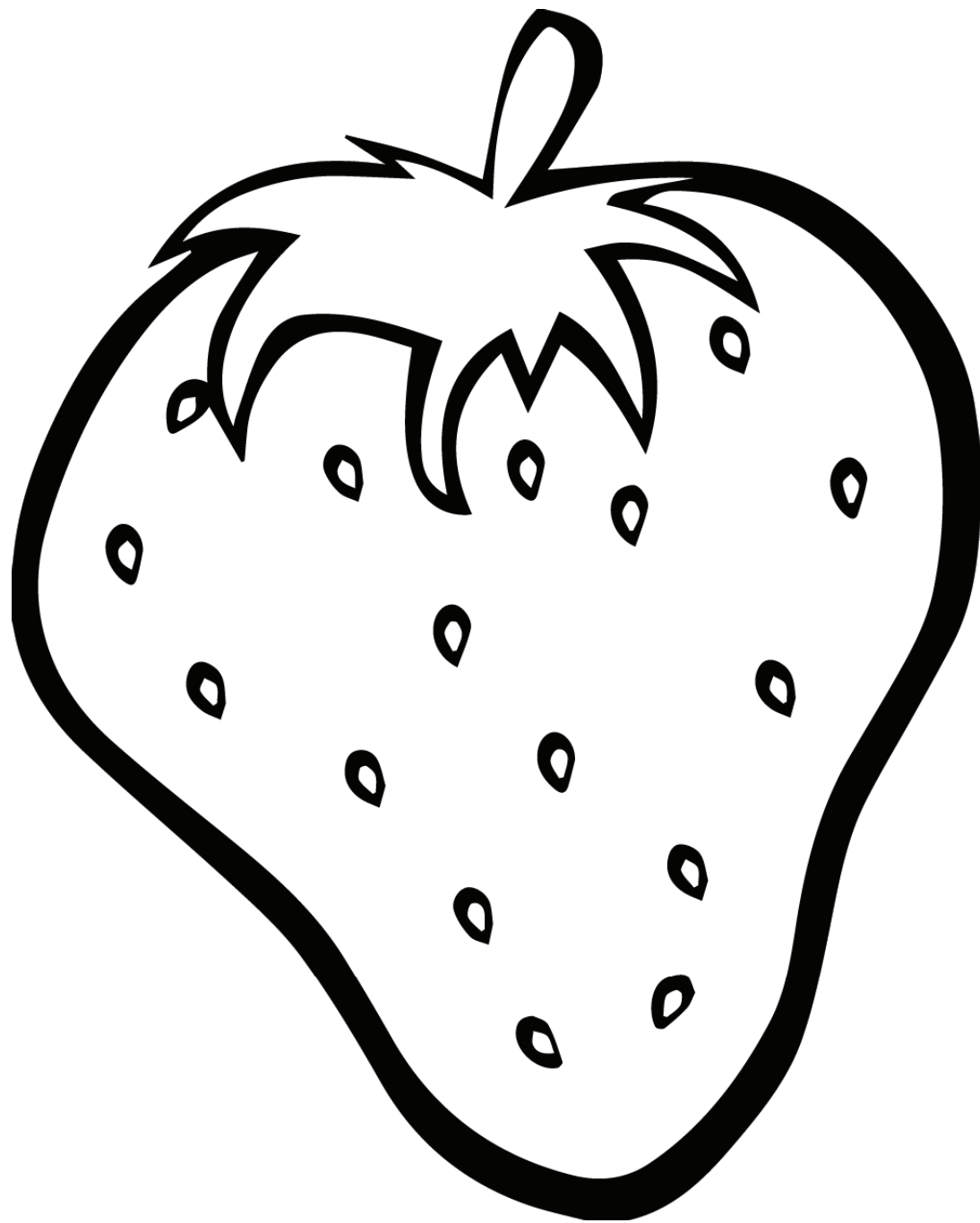

red

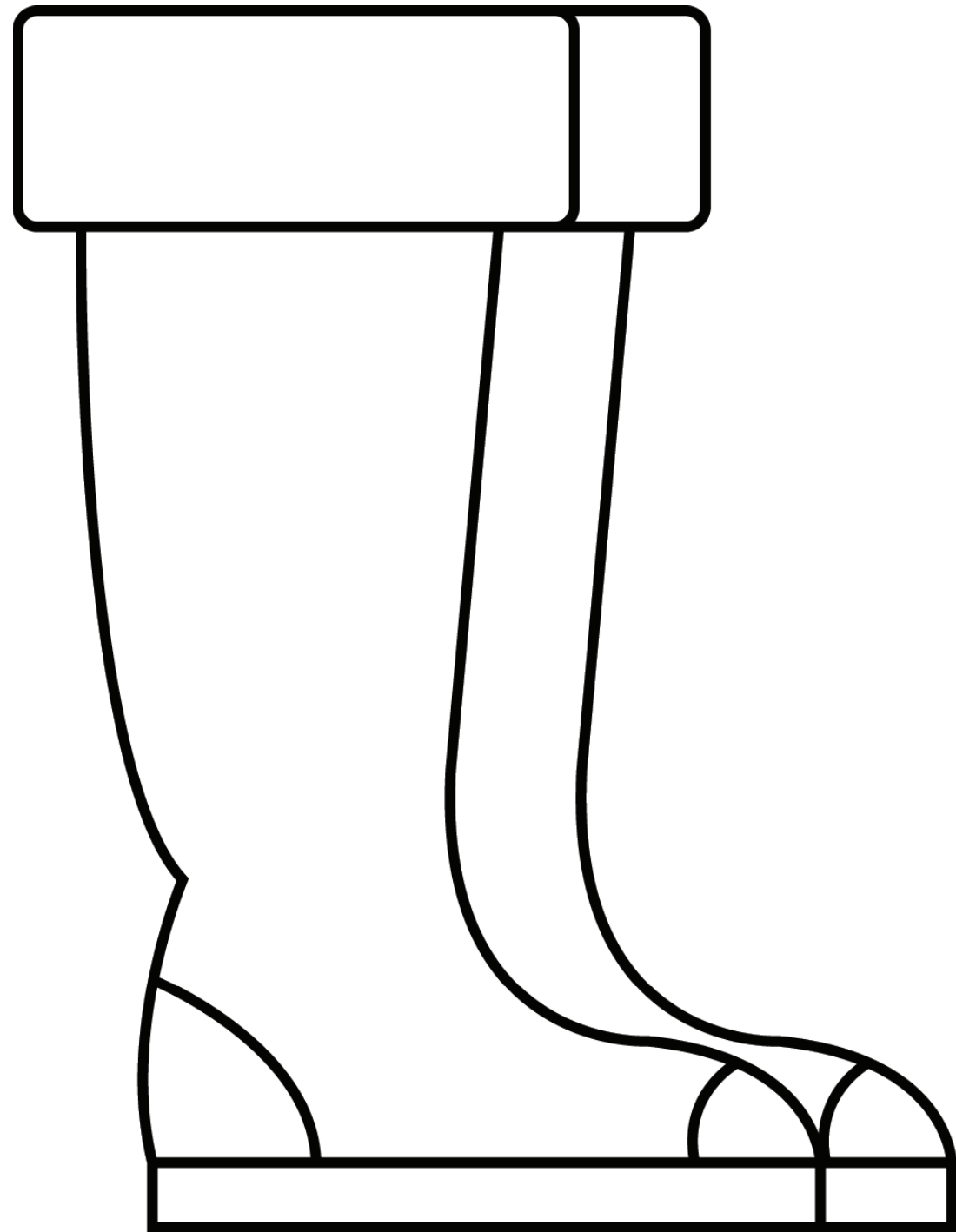

boots



wear

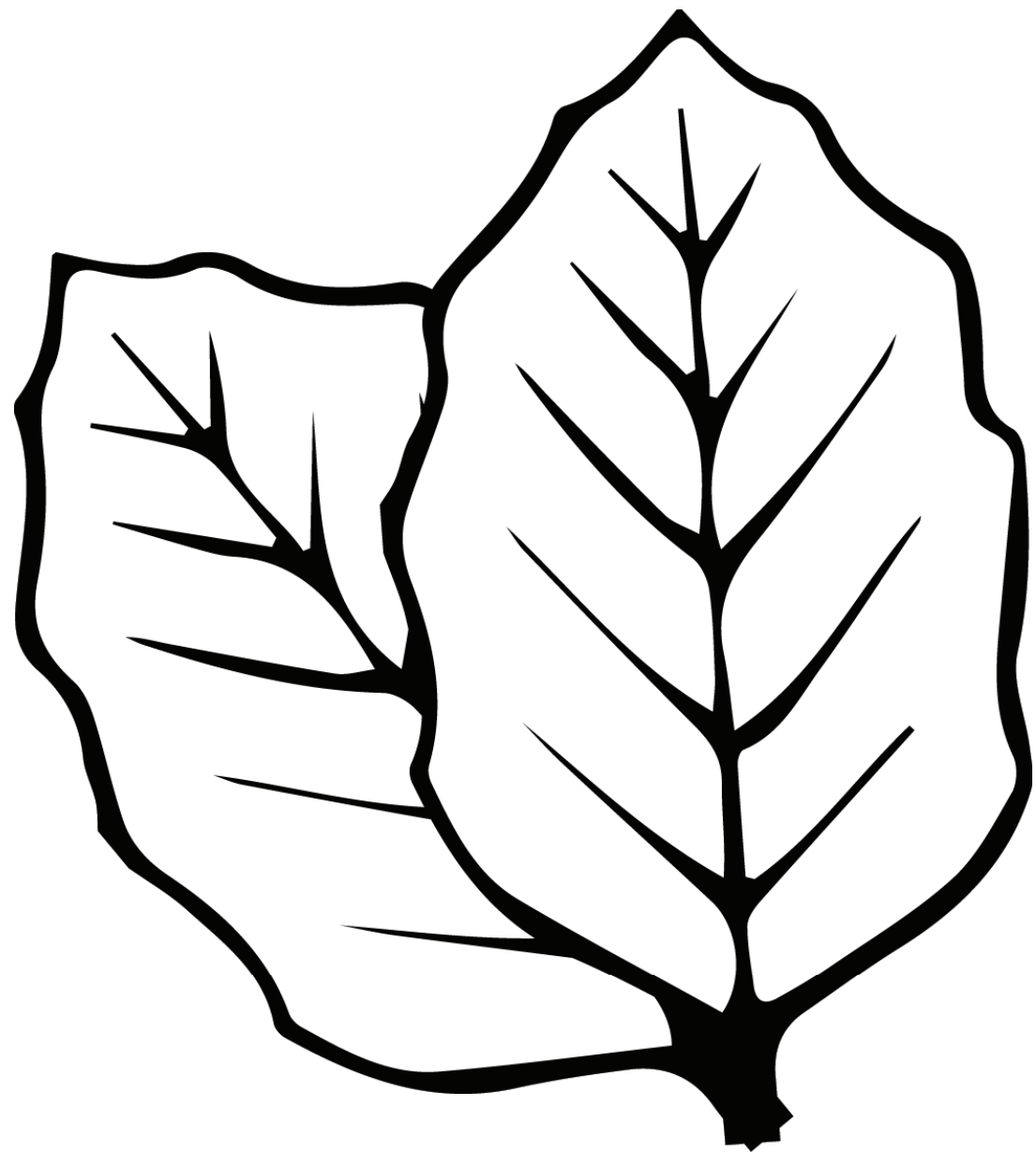

green

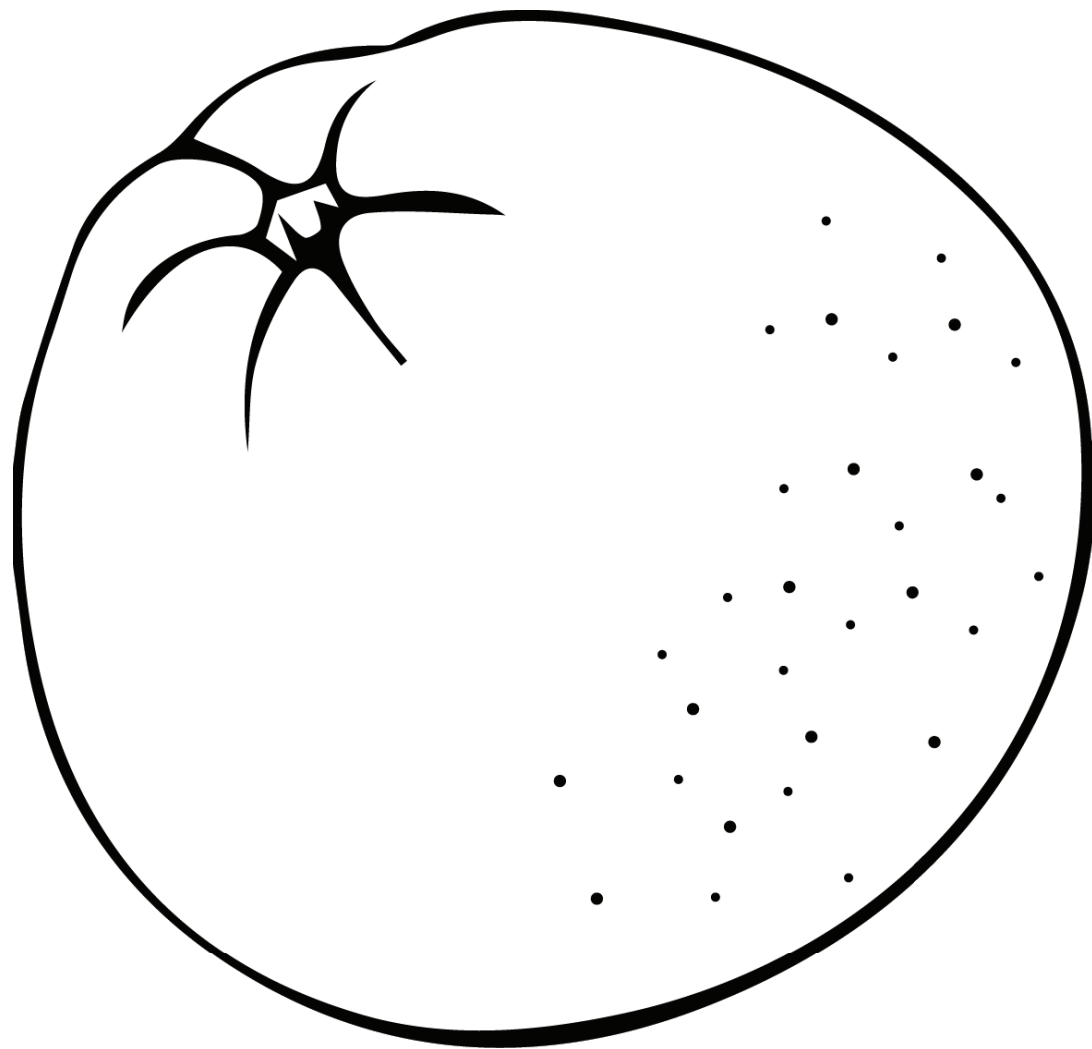

orange

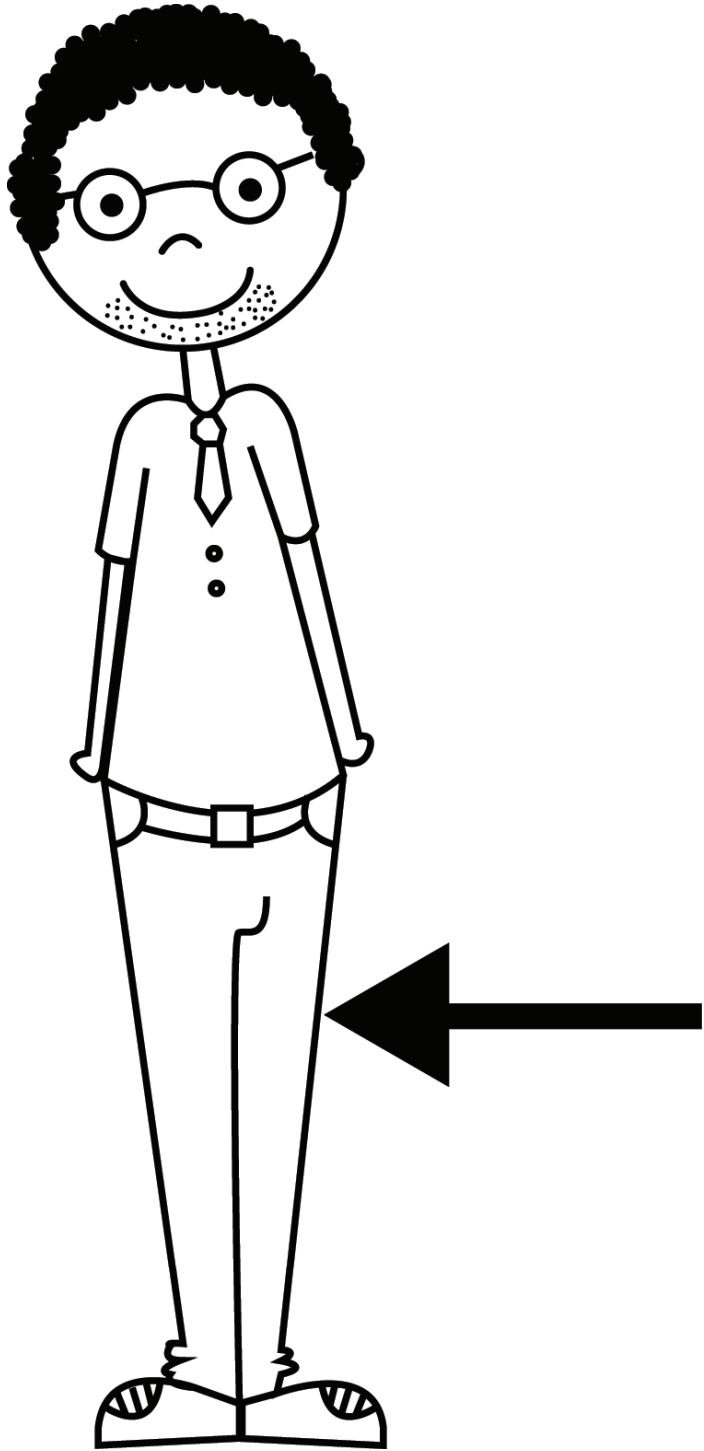

pants

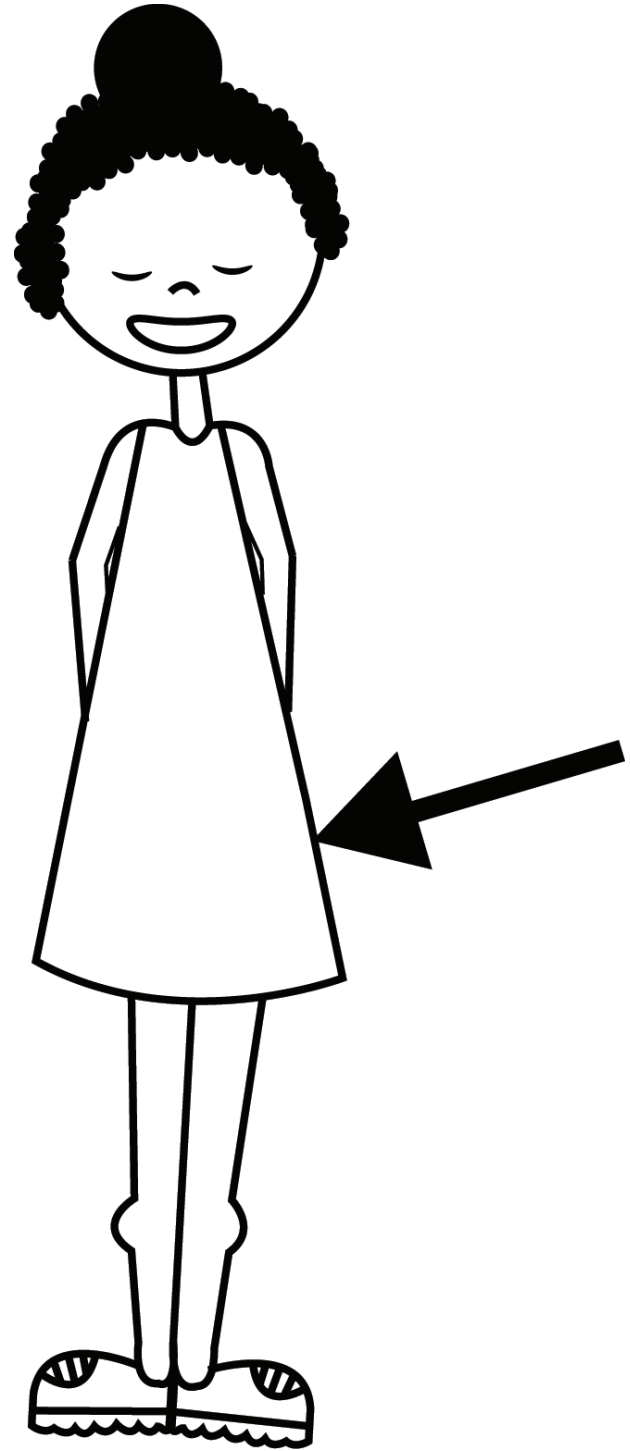

dress

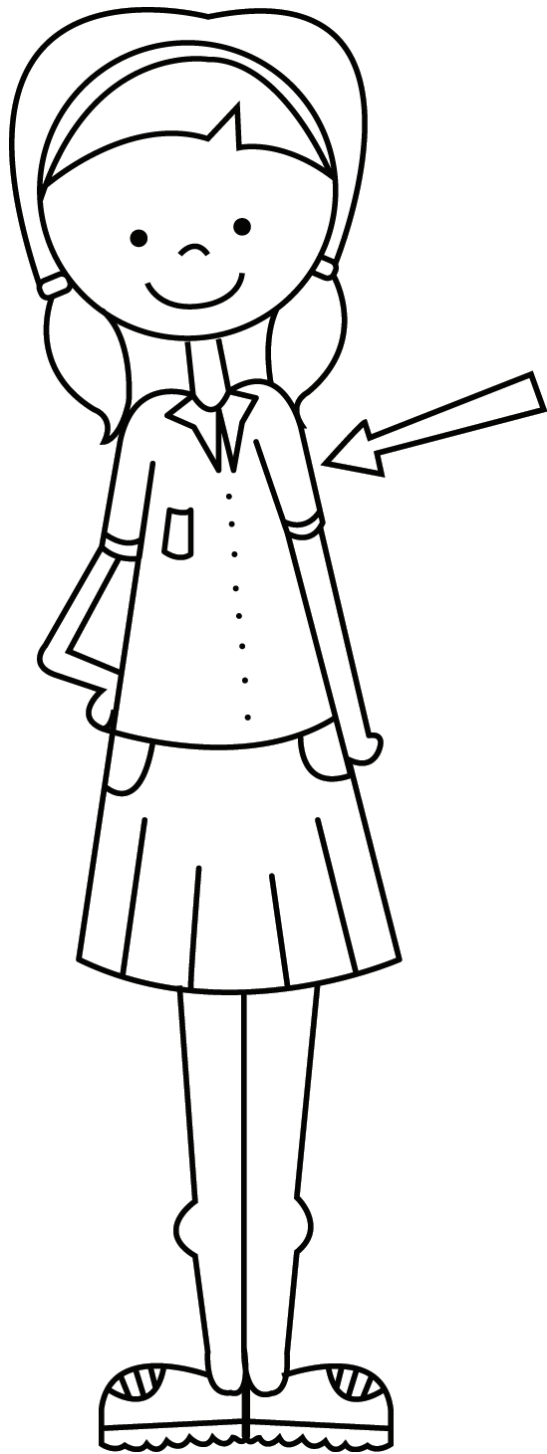

uniform

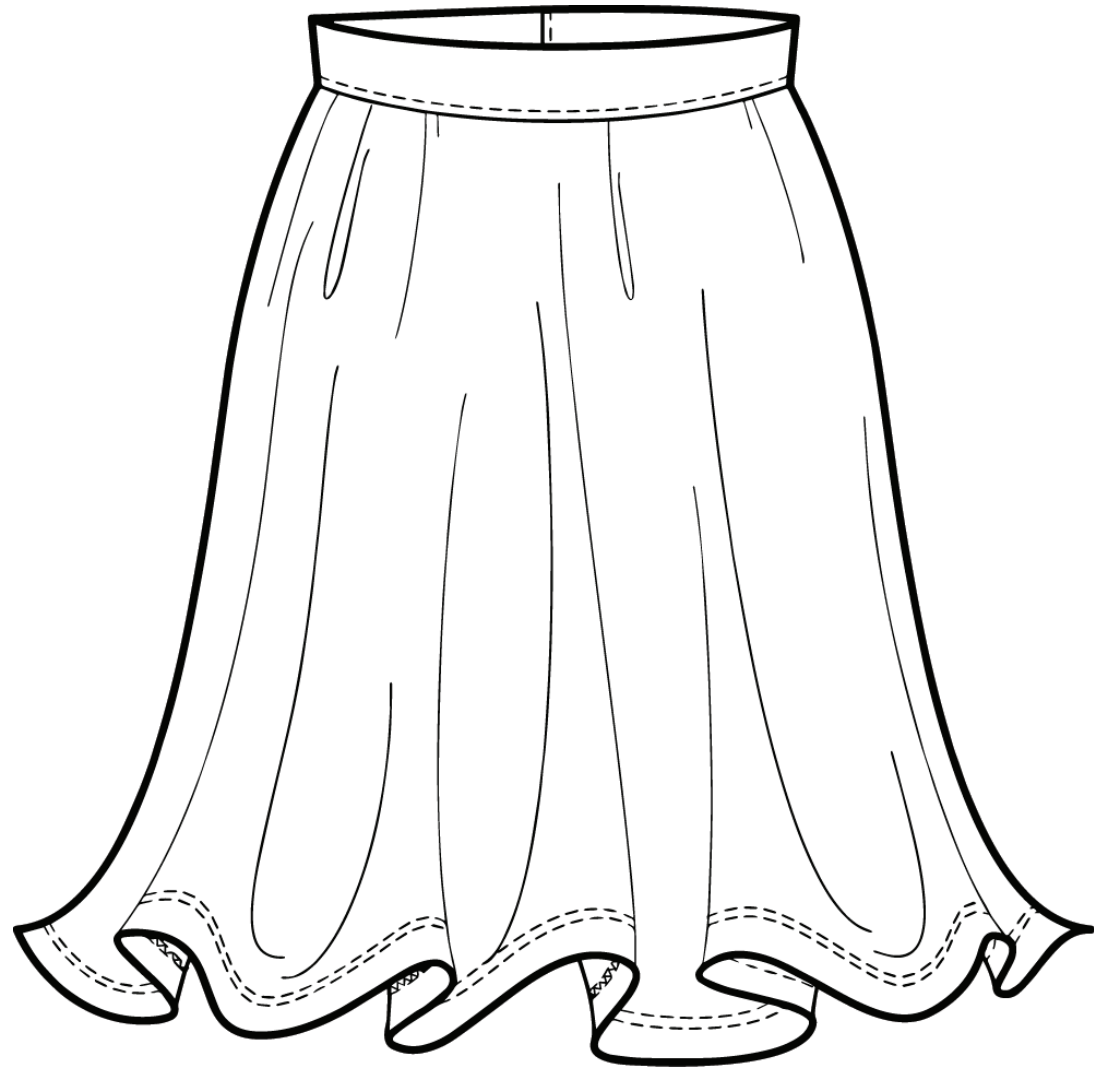

skirt



shirt

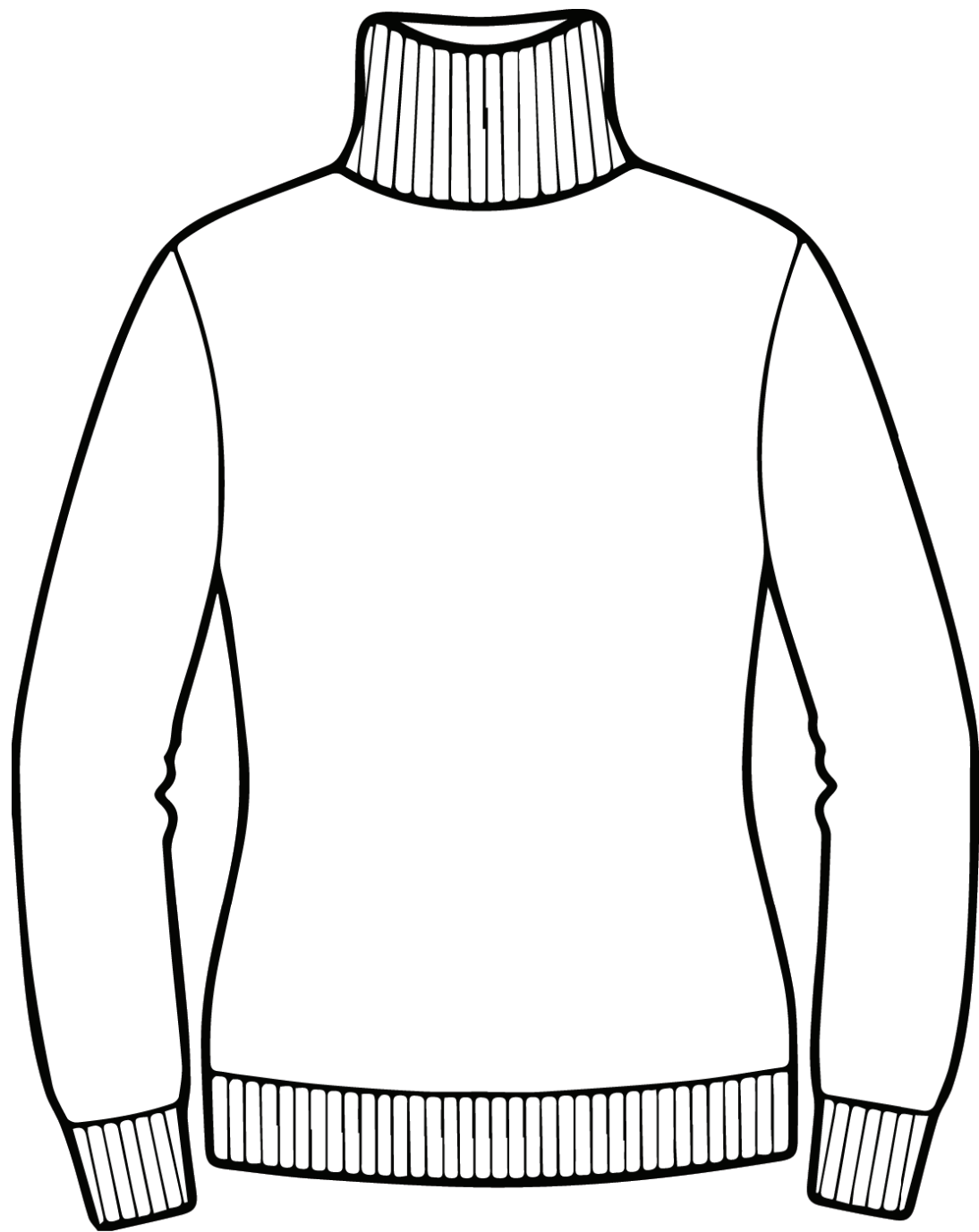

jersey

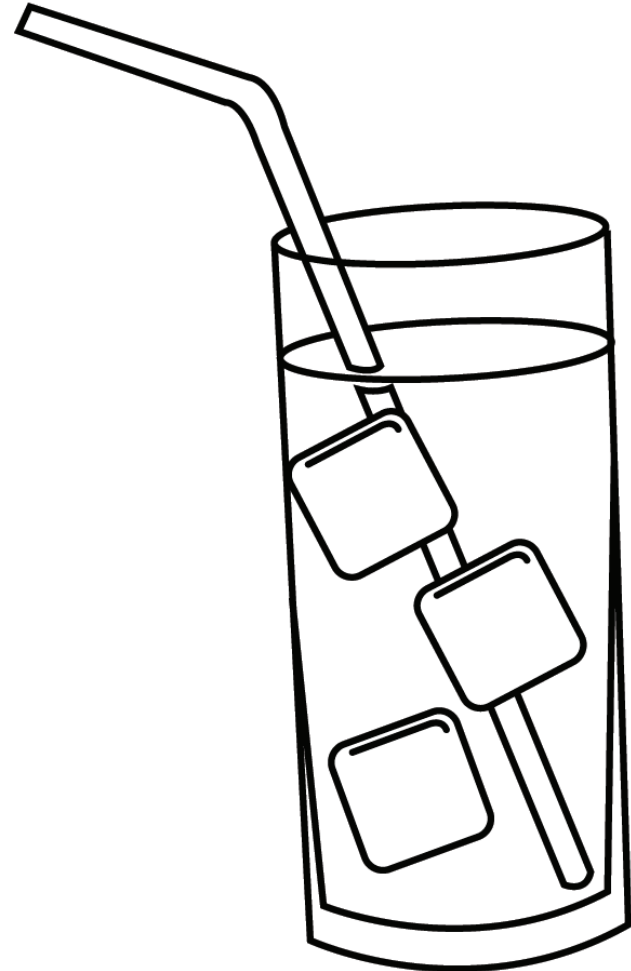
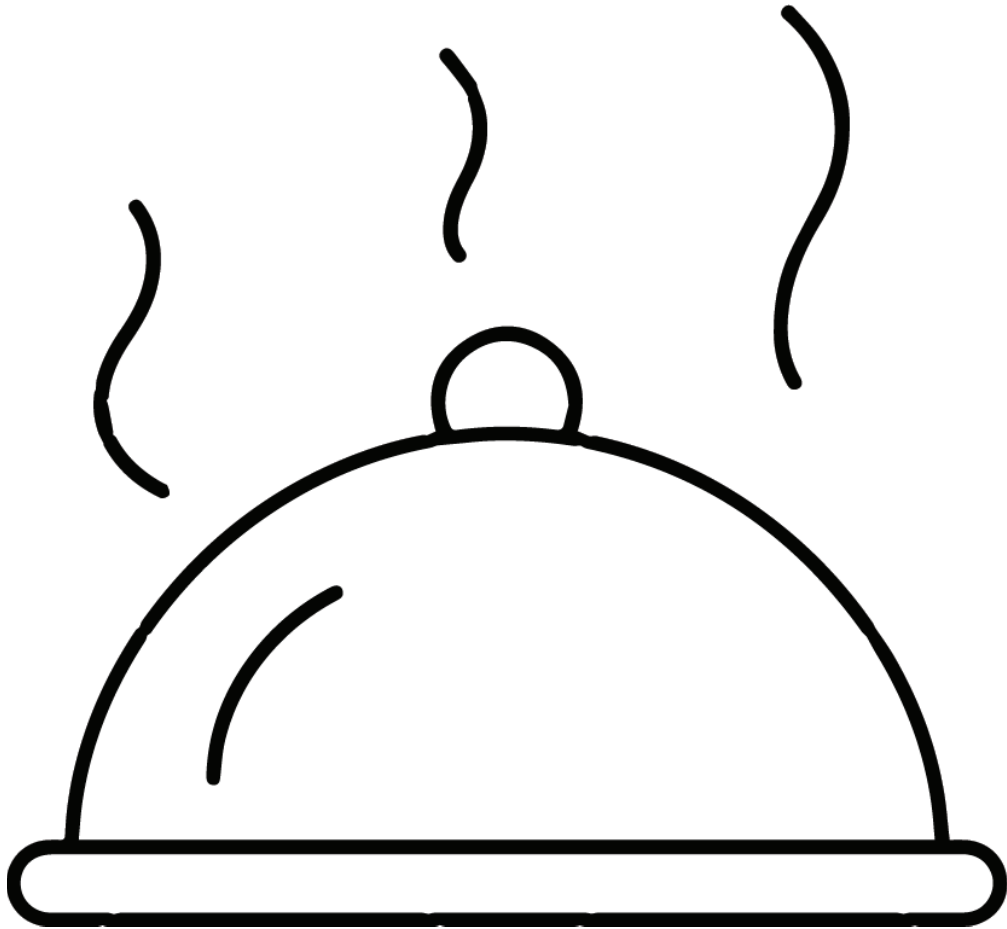
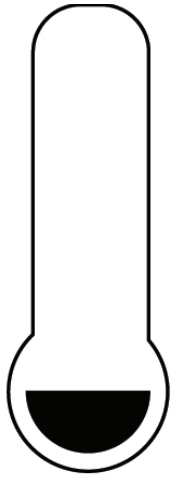
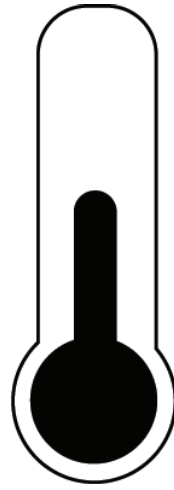

warm

cold



puddle



rain



dry

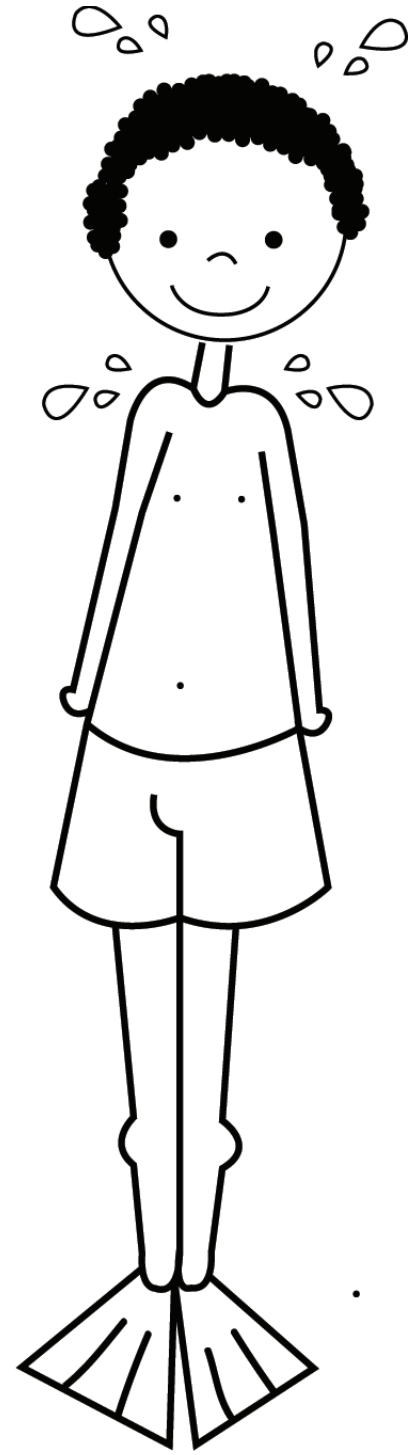

wet

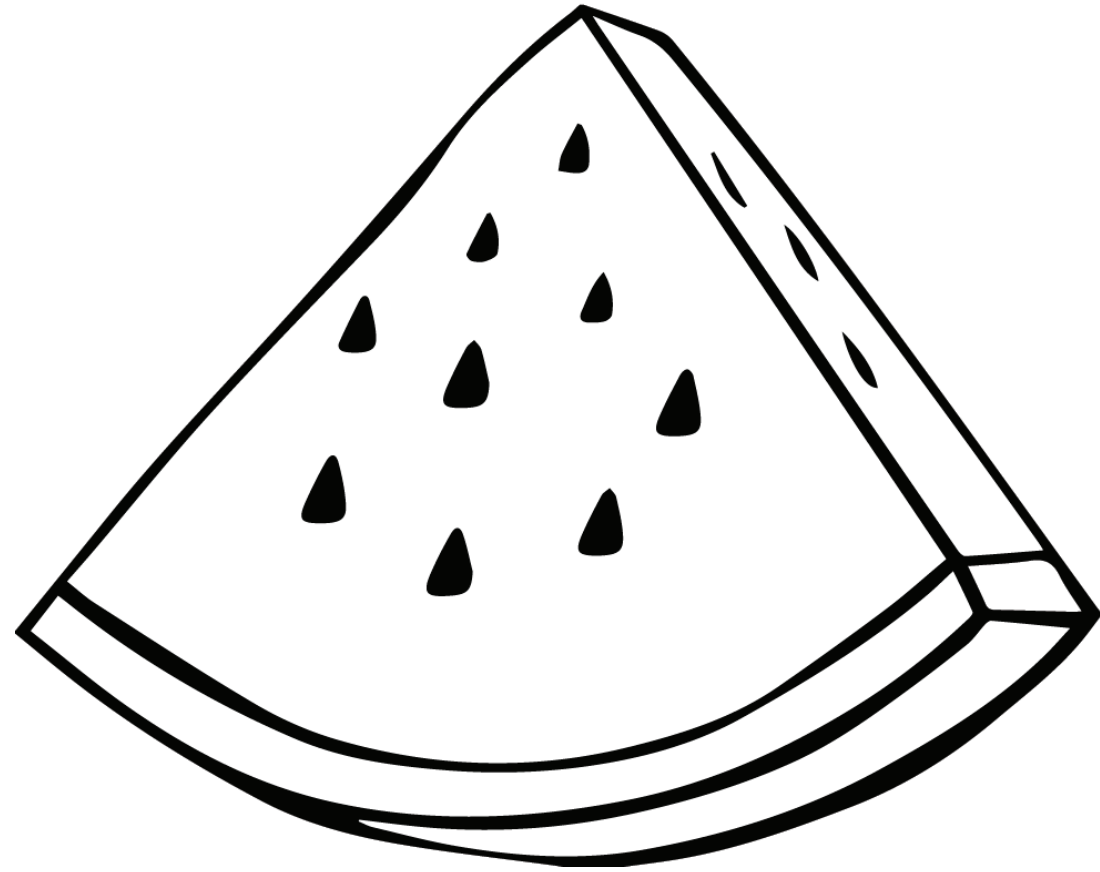

pink



t-shirt

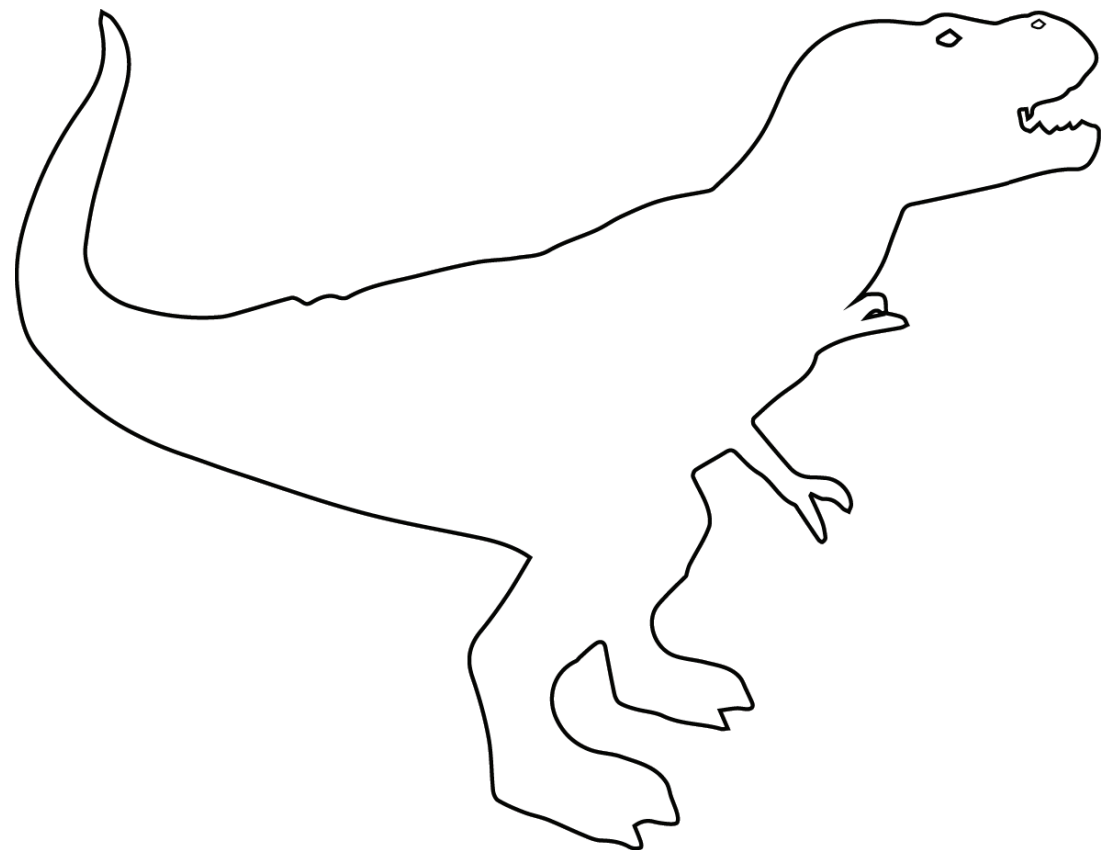

dinosaur

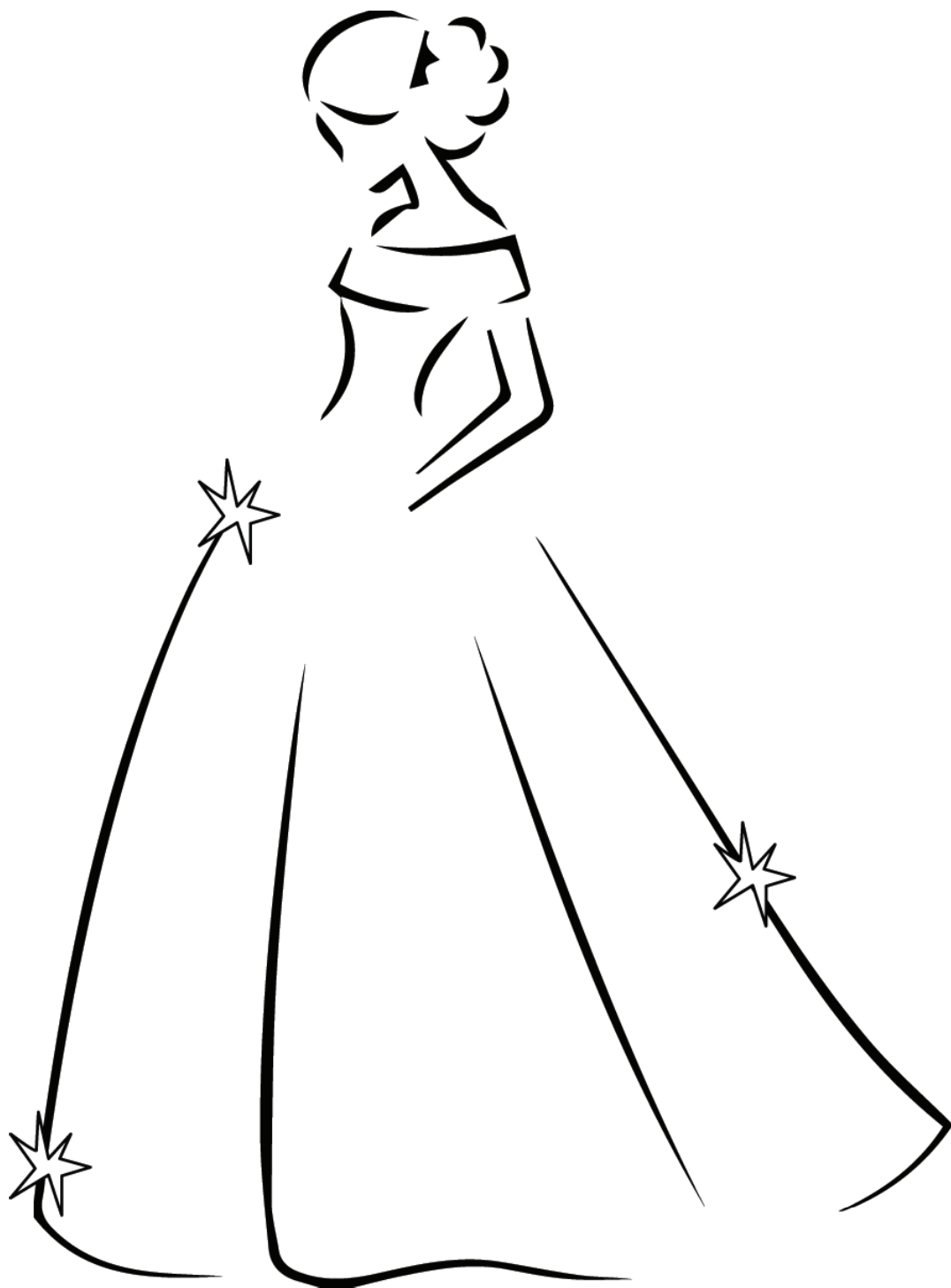

white

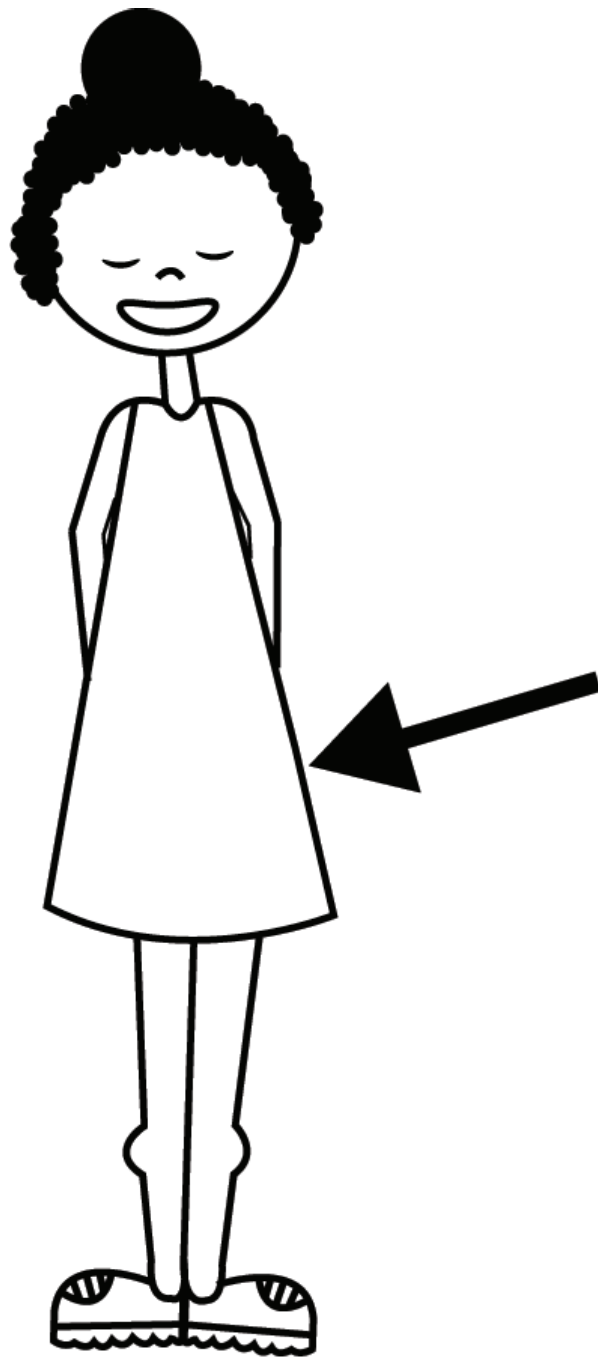
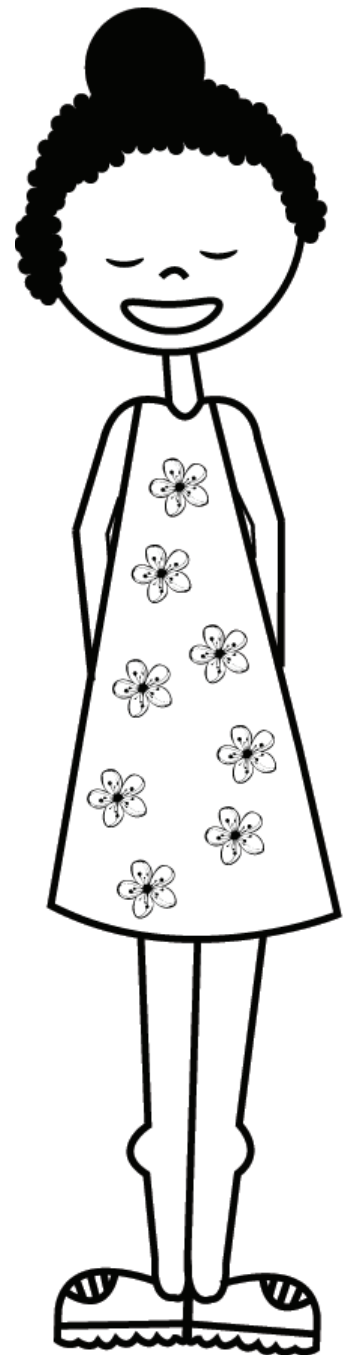

plain

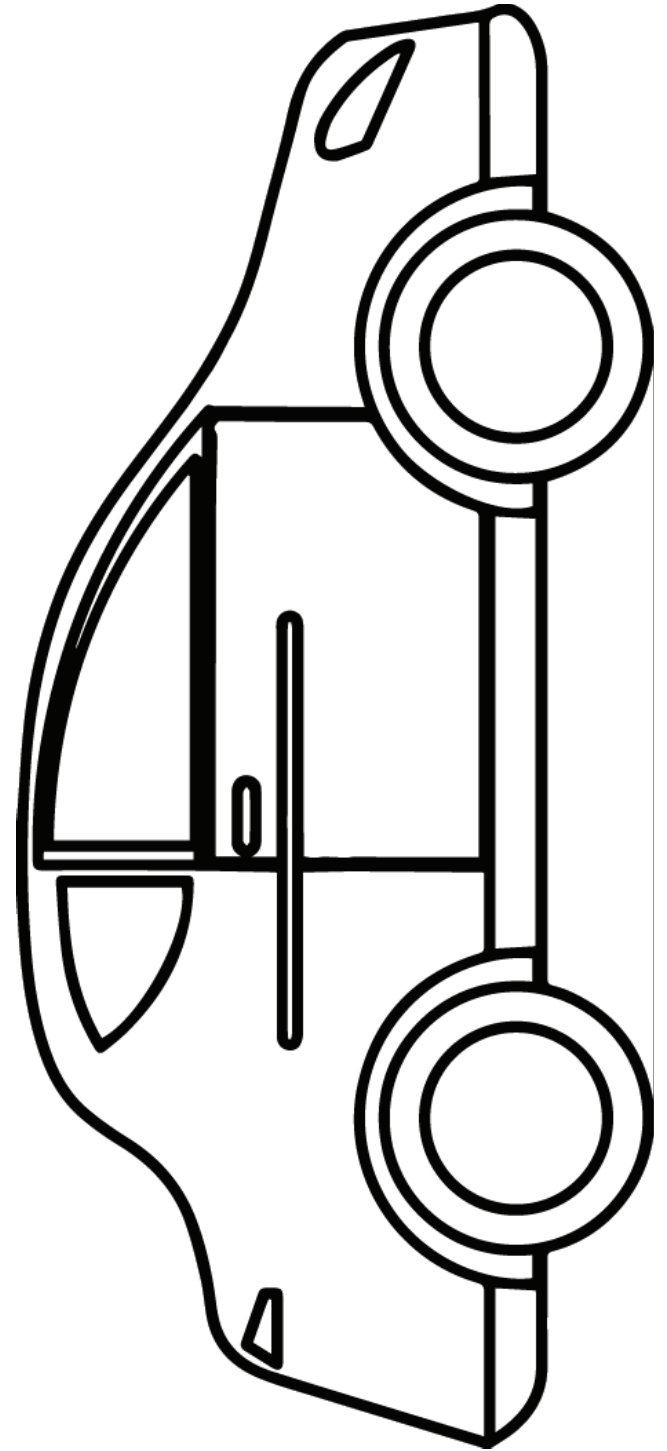

car



disagree

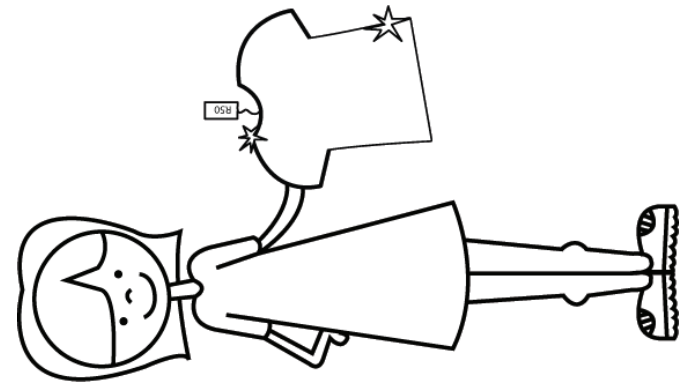
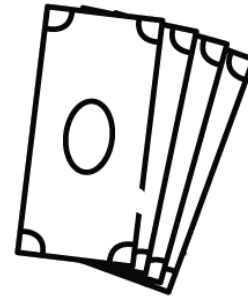
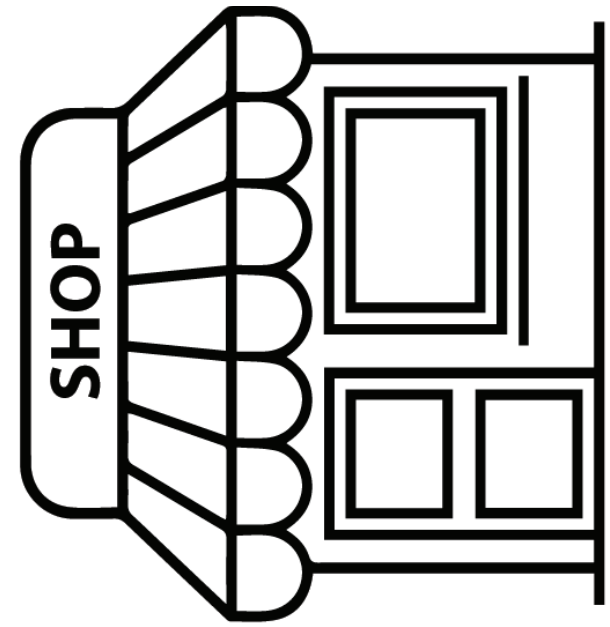

buy



shopping

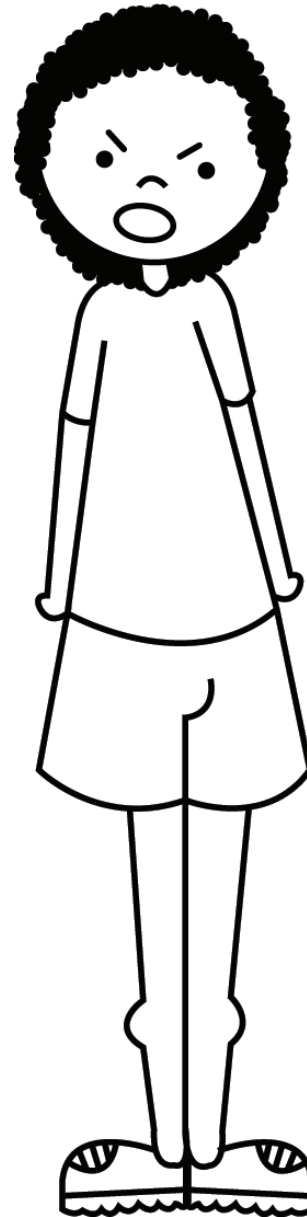

No! blah!

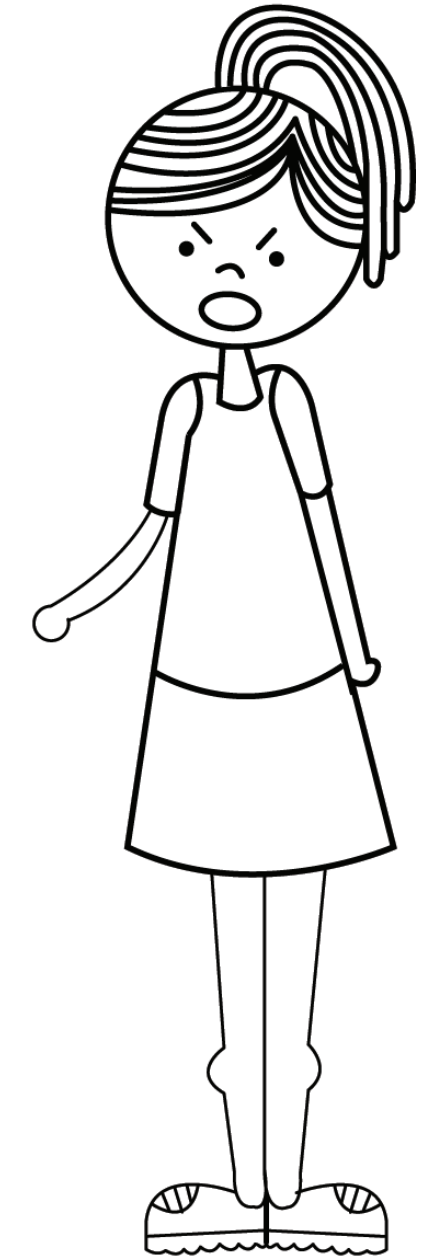

blah blah!

argue

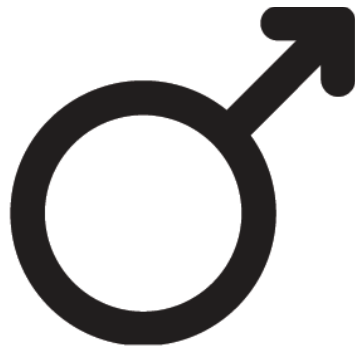
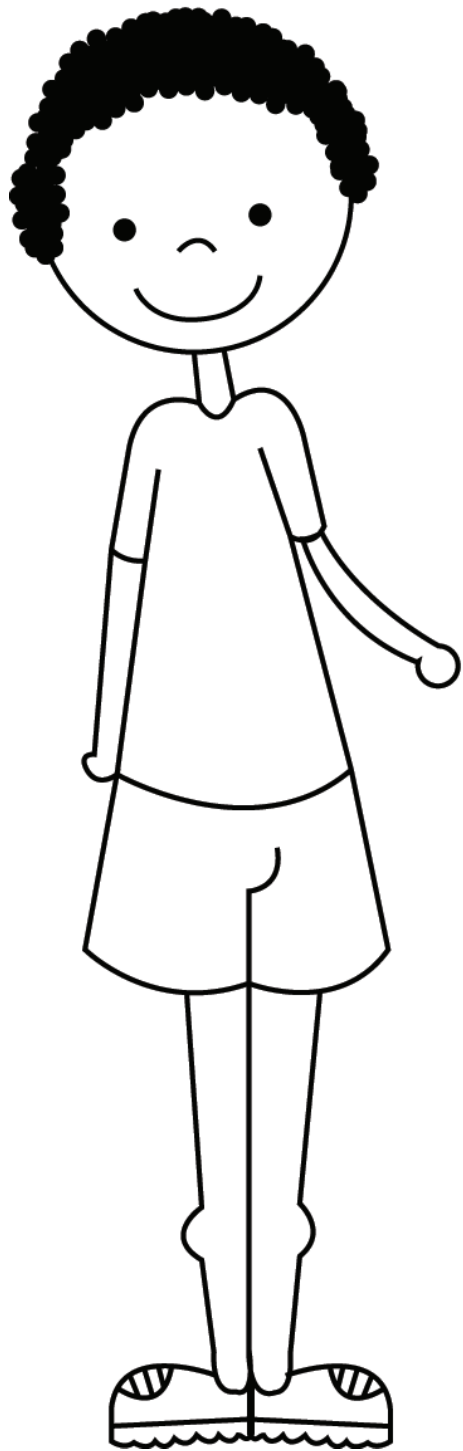

boy



frustrated

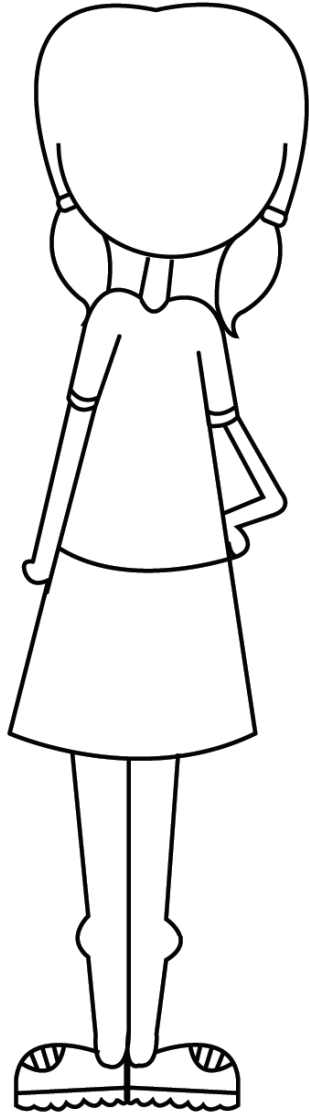
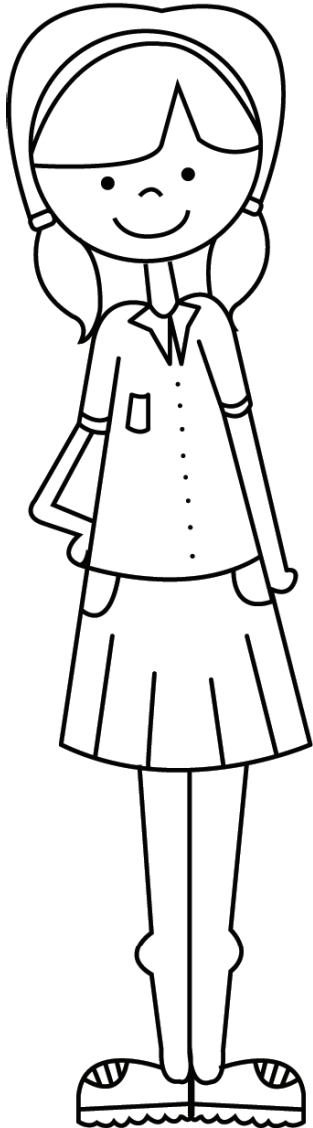
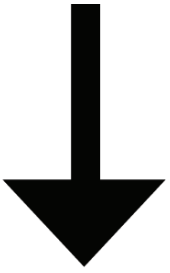

front

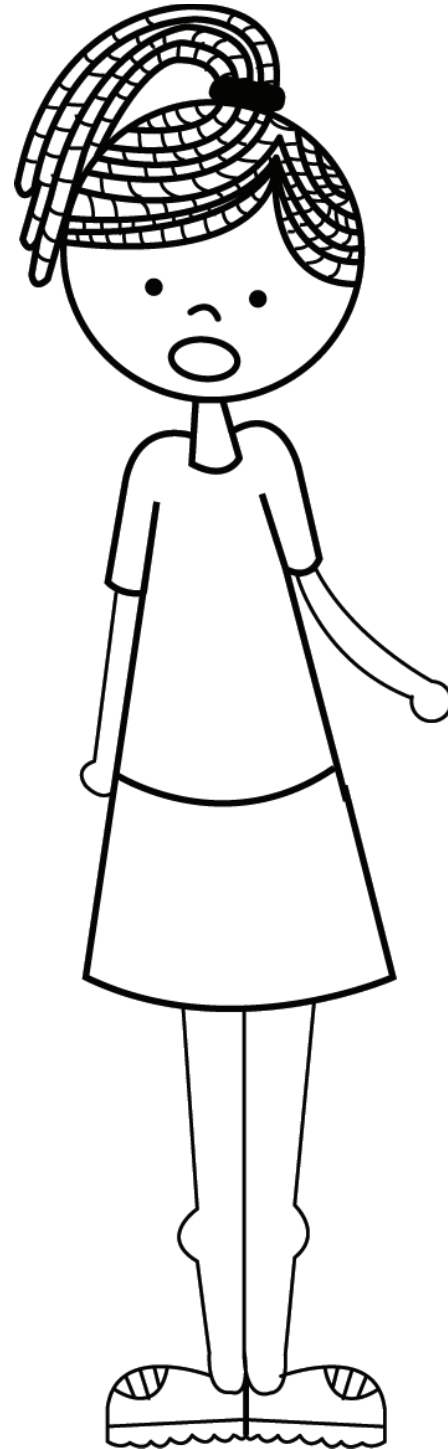

girl

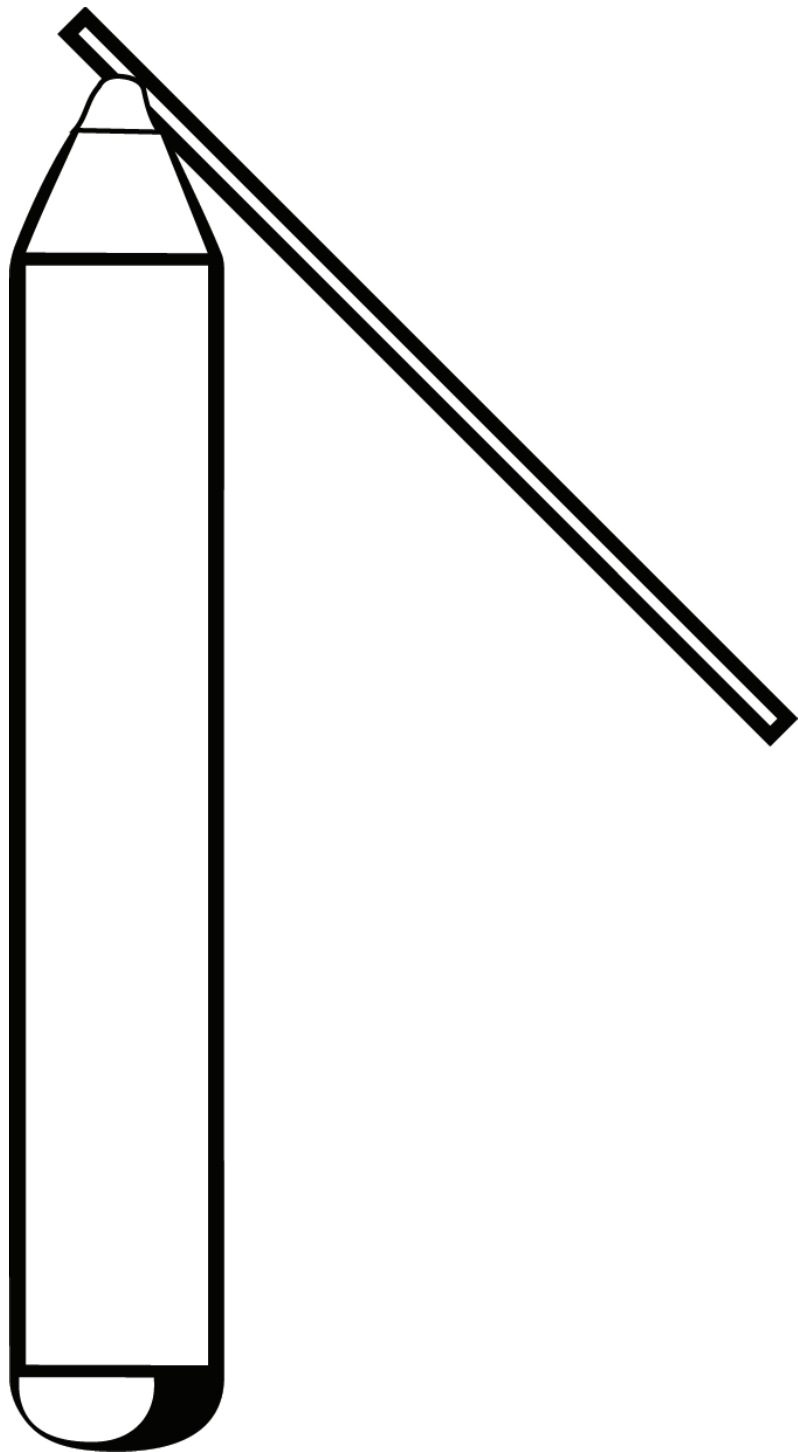

koki pen

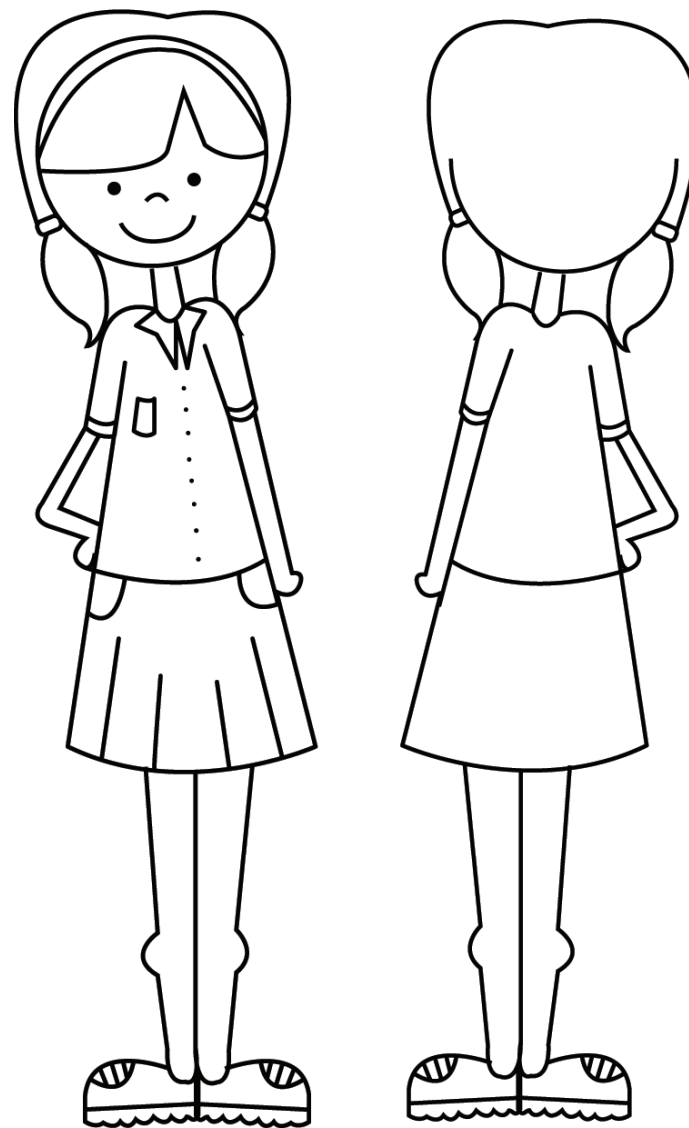

back

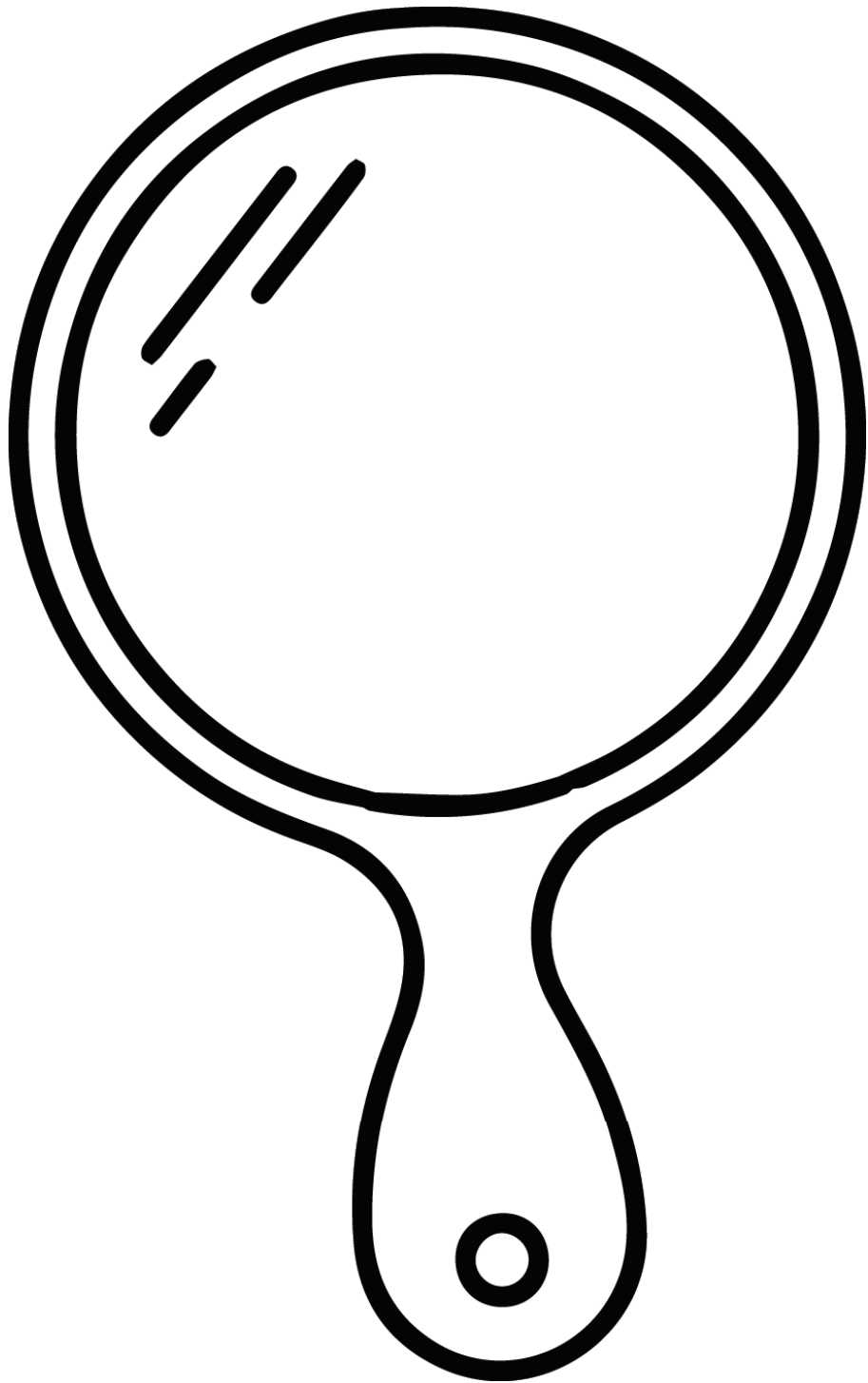

mirror

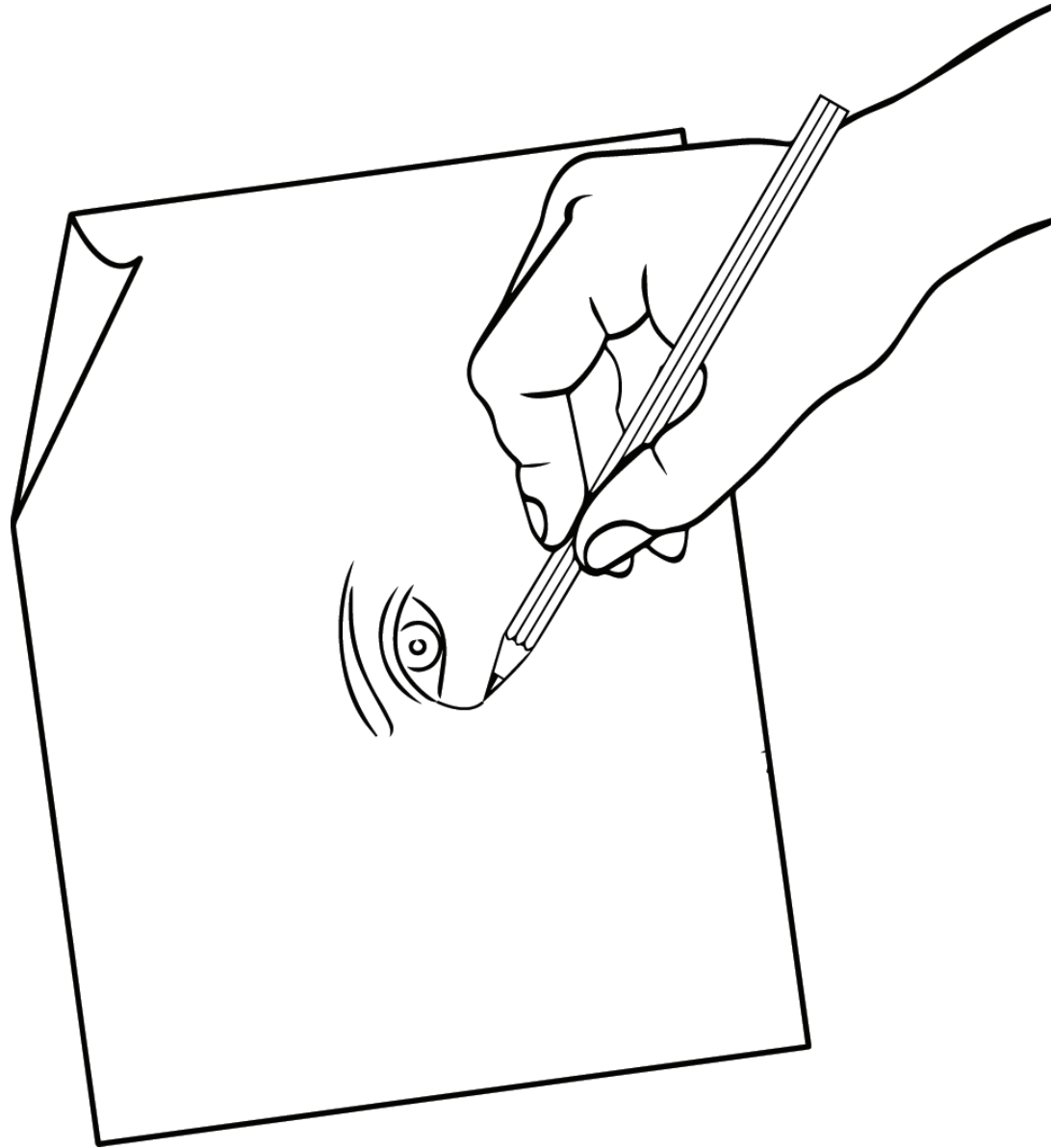

draw

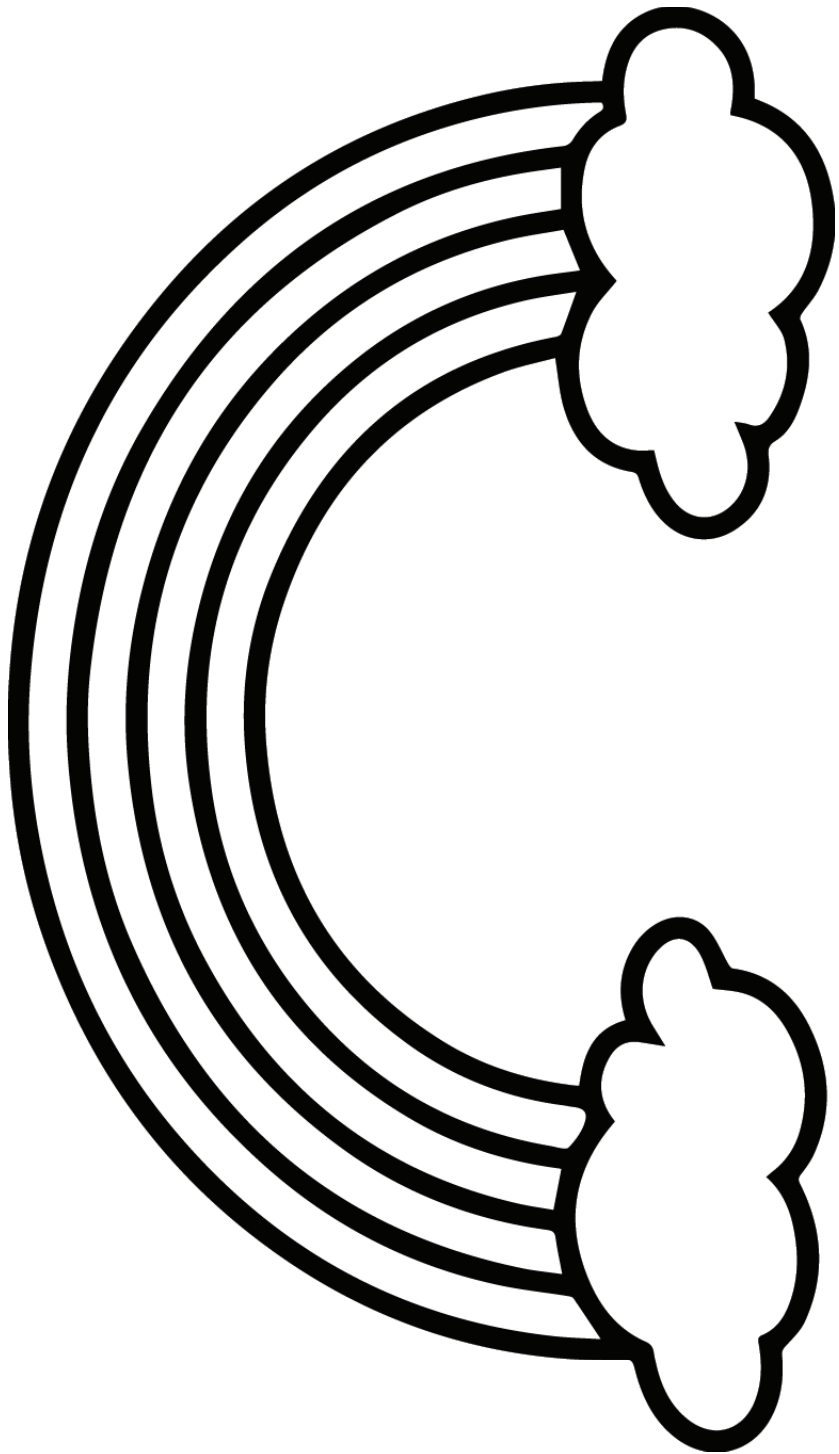

colourful



high five

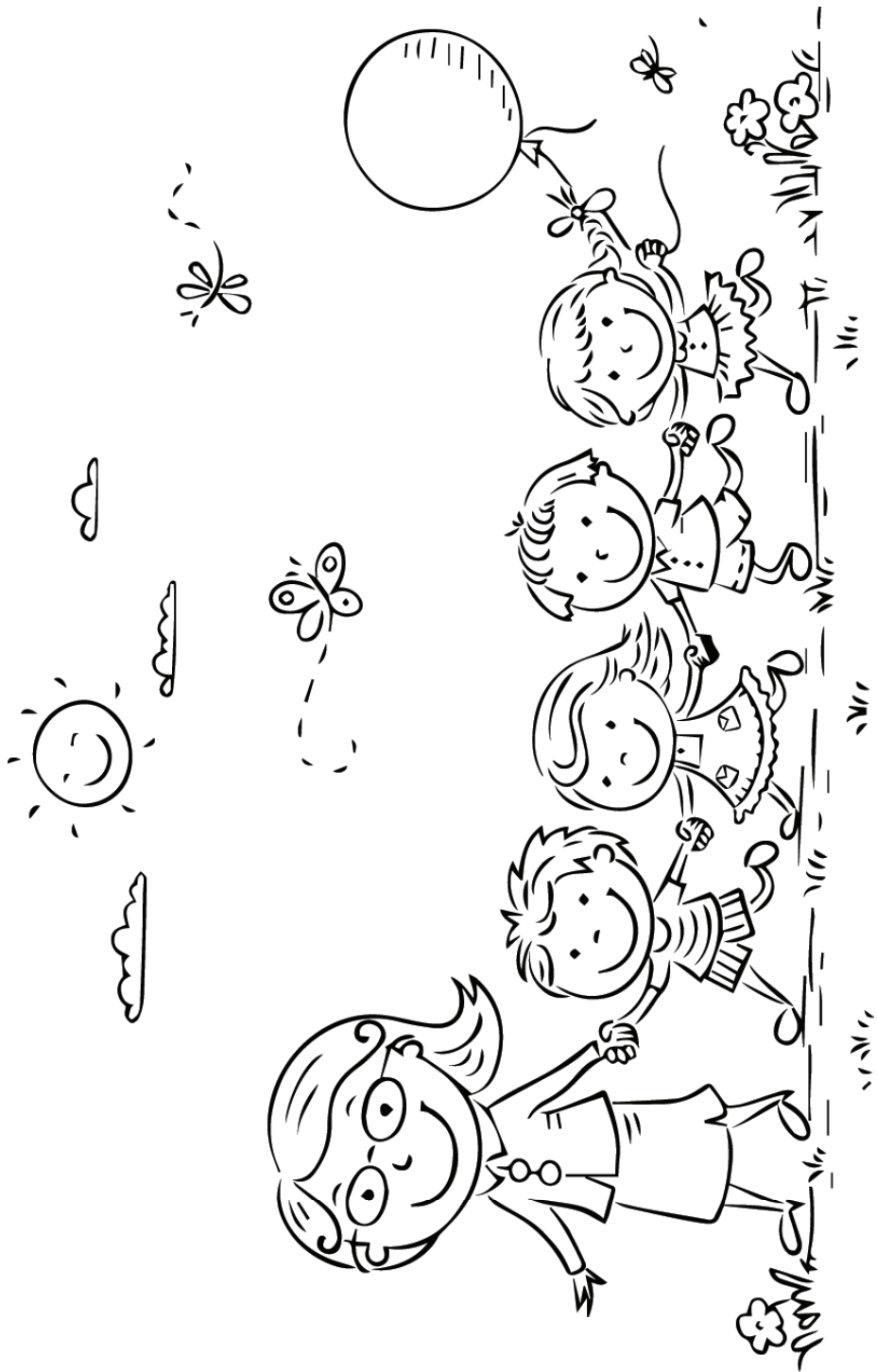

fun

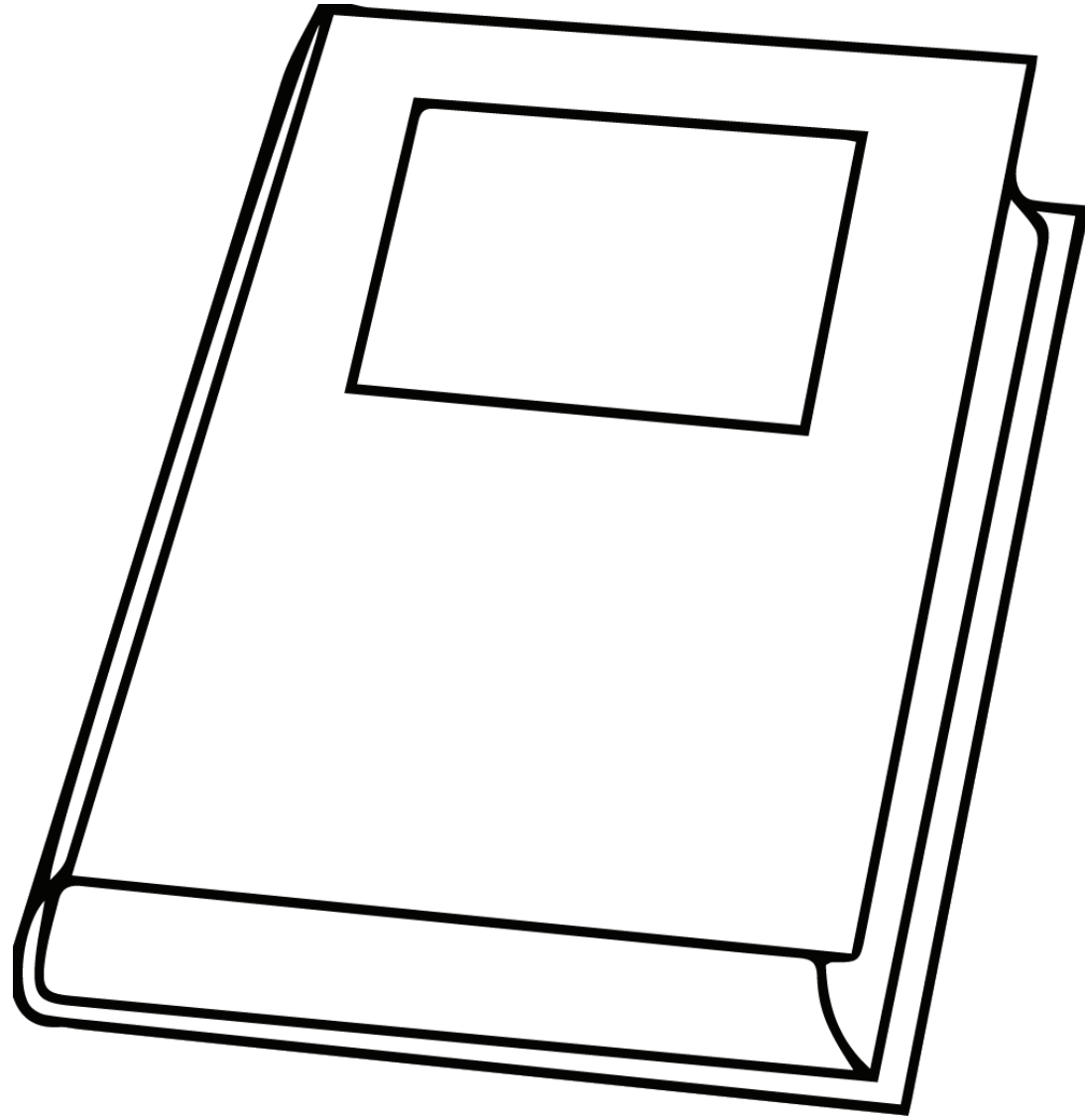

book

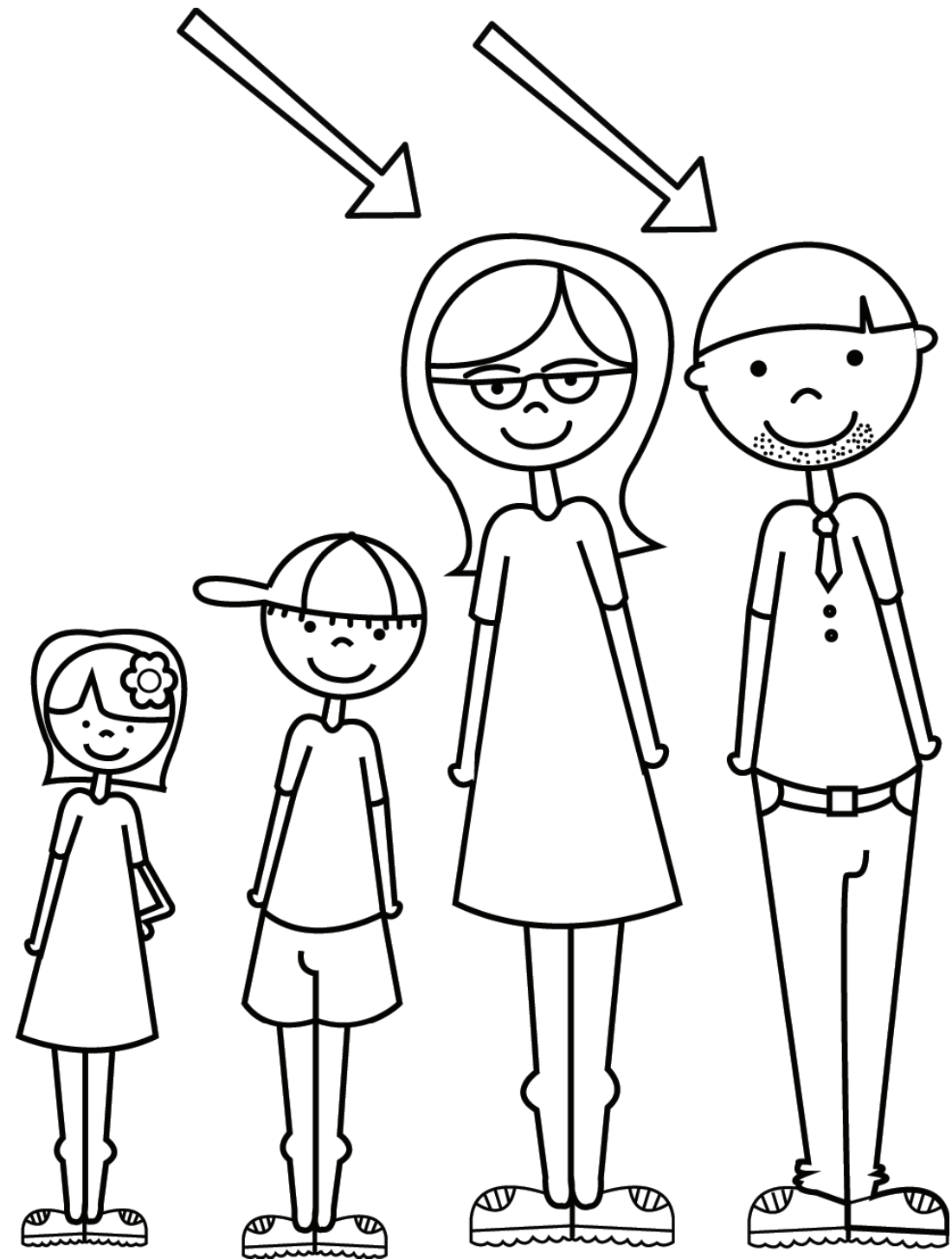

parents

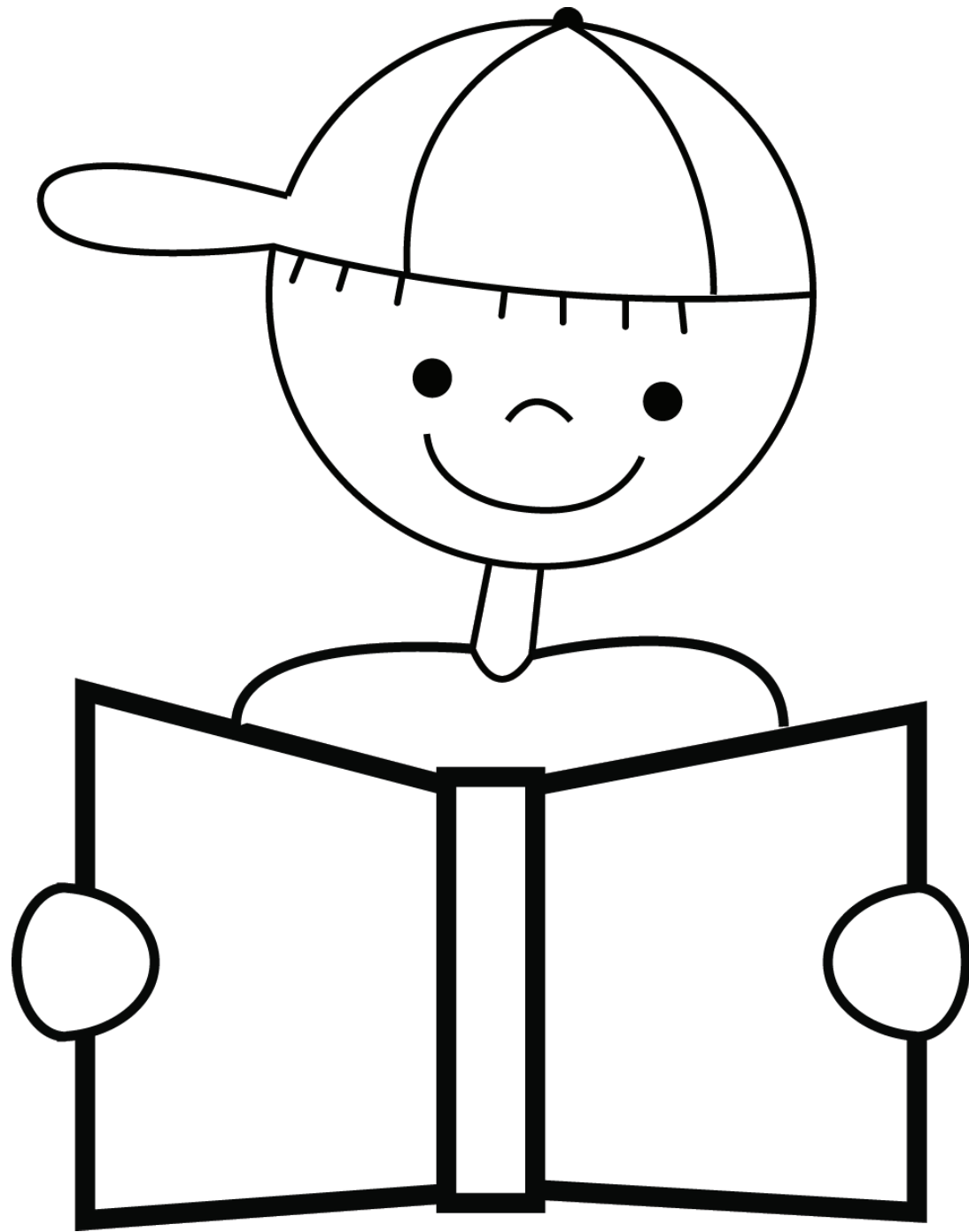

read



turn

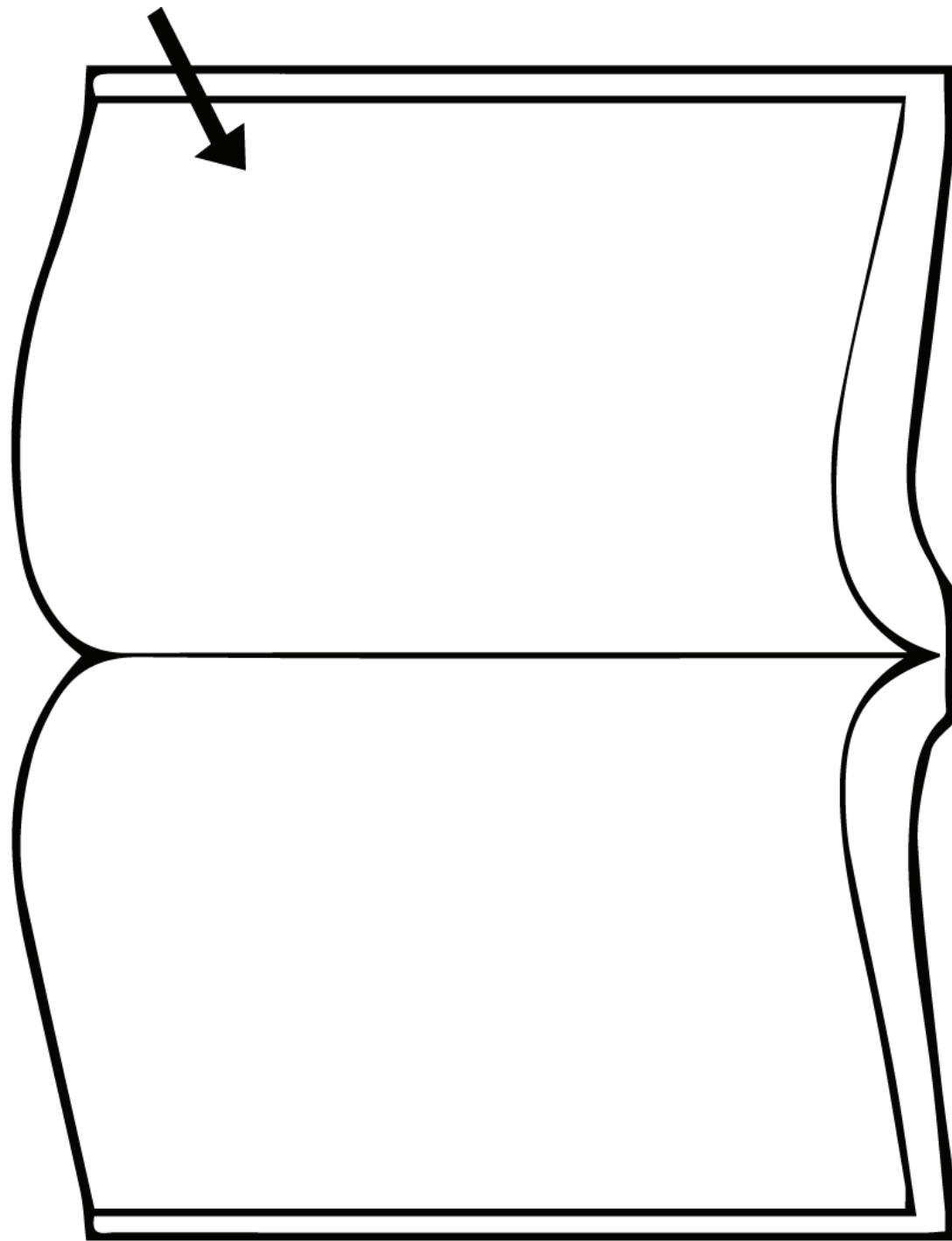

page

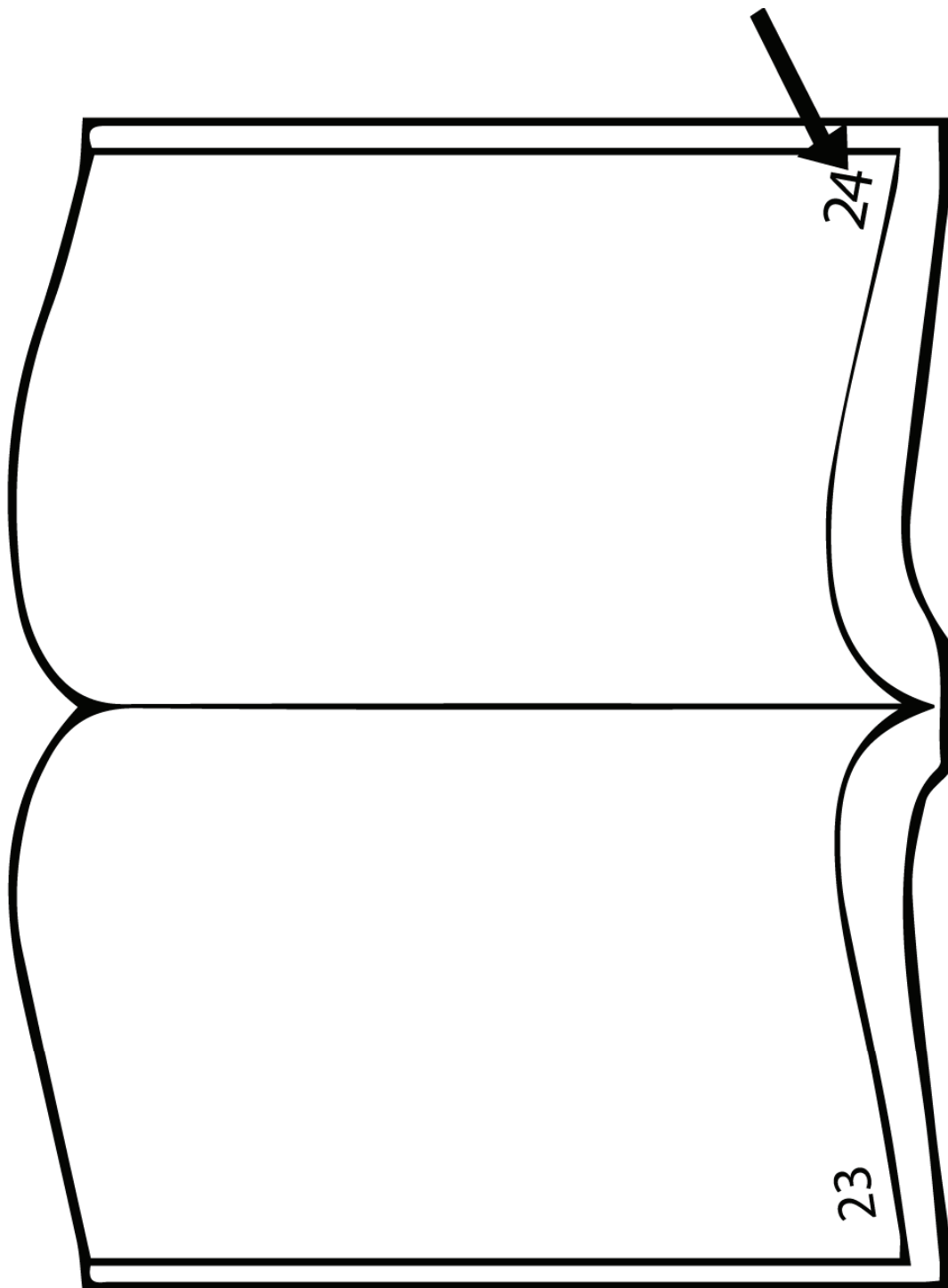

page number

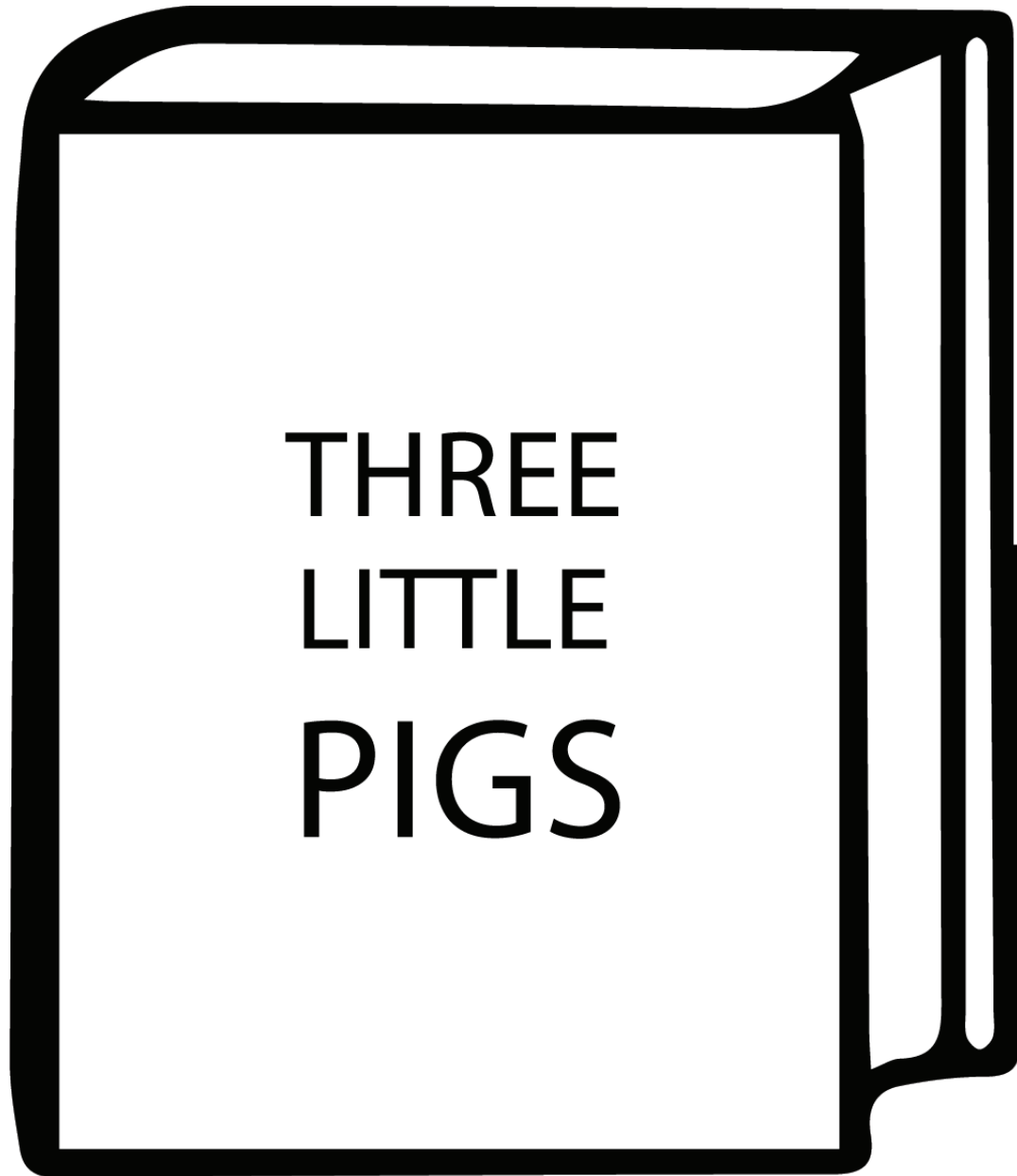

title

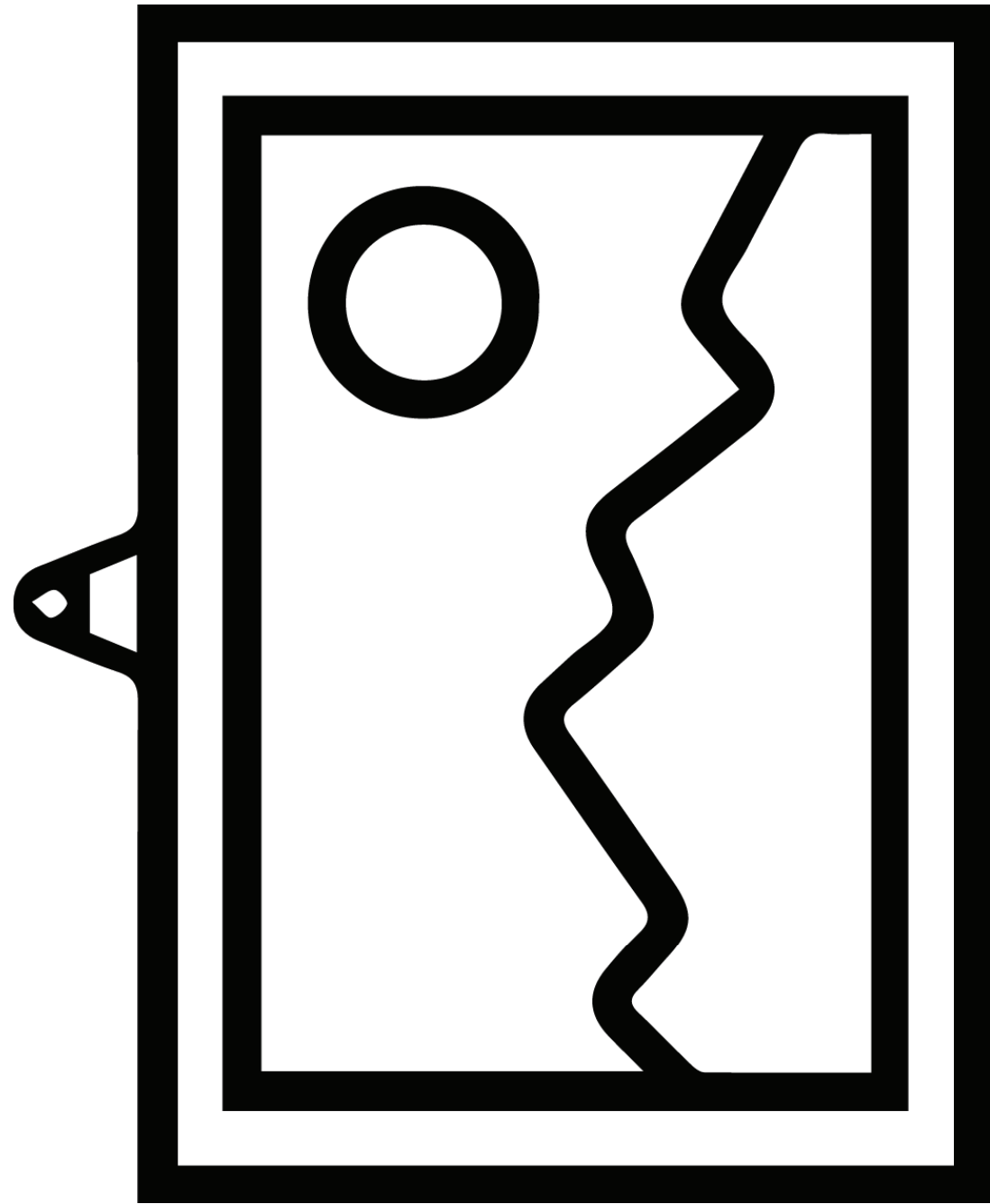

picture

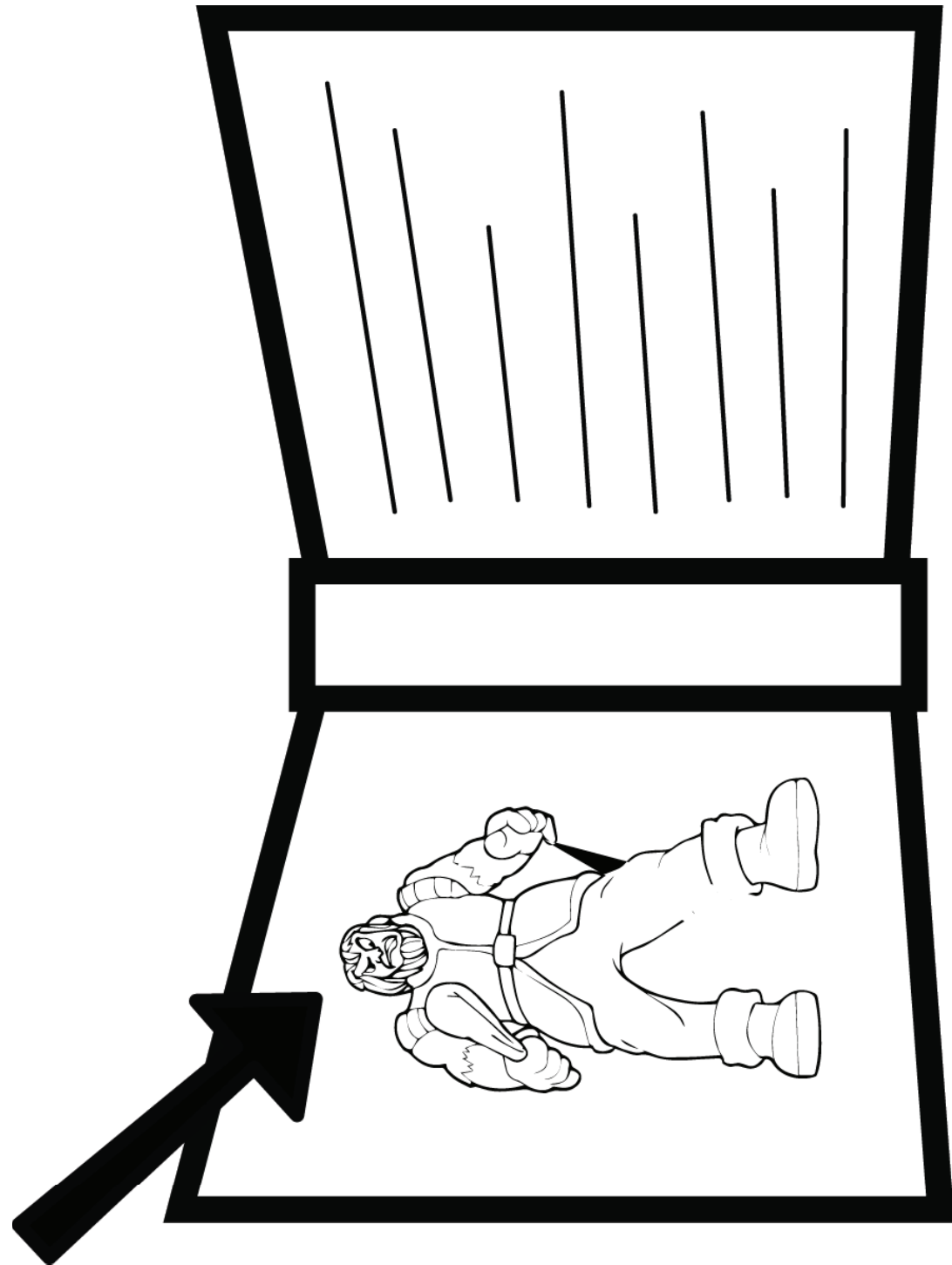

character

peace
happiness
Hello!
words
because
delicious
beautiful
swan
sky

words



ignore

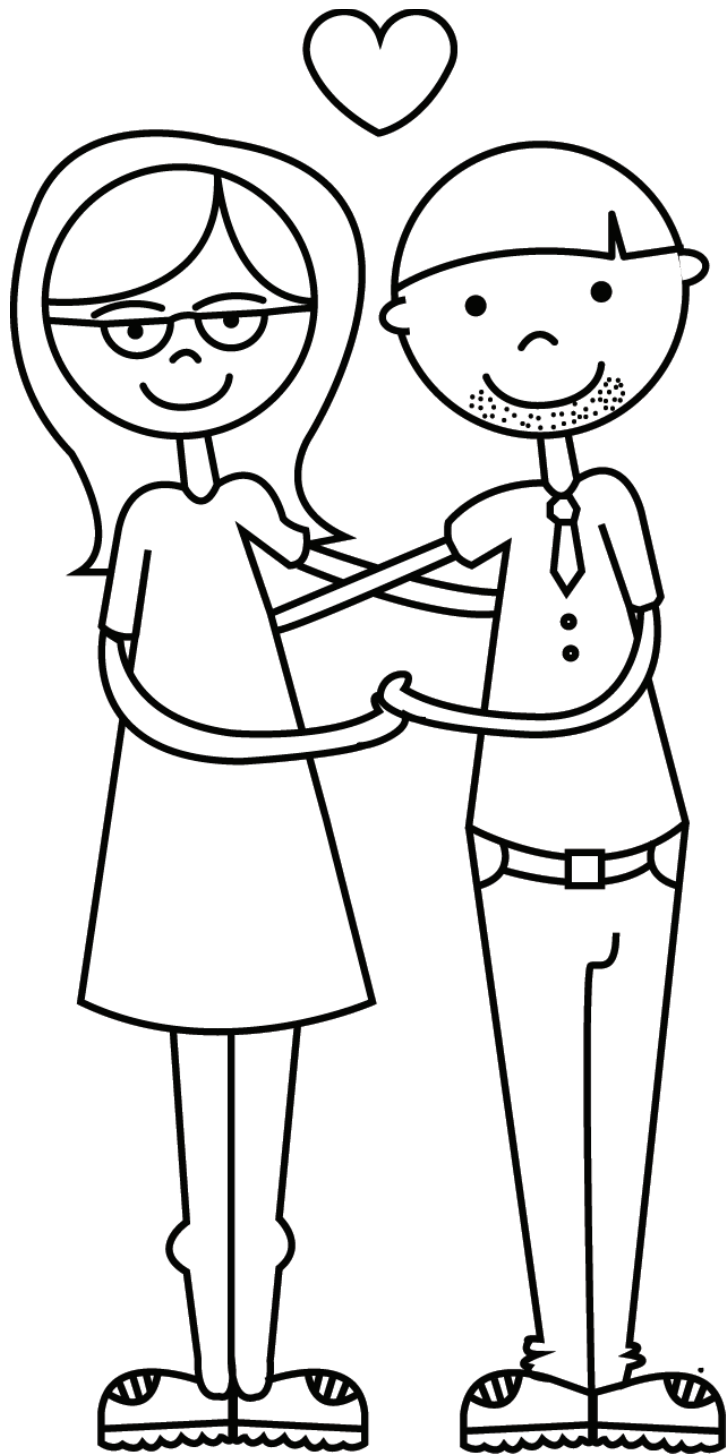

in love

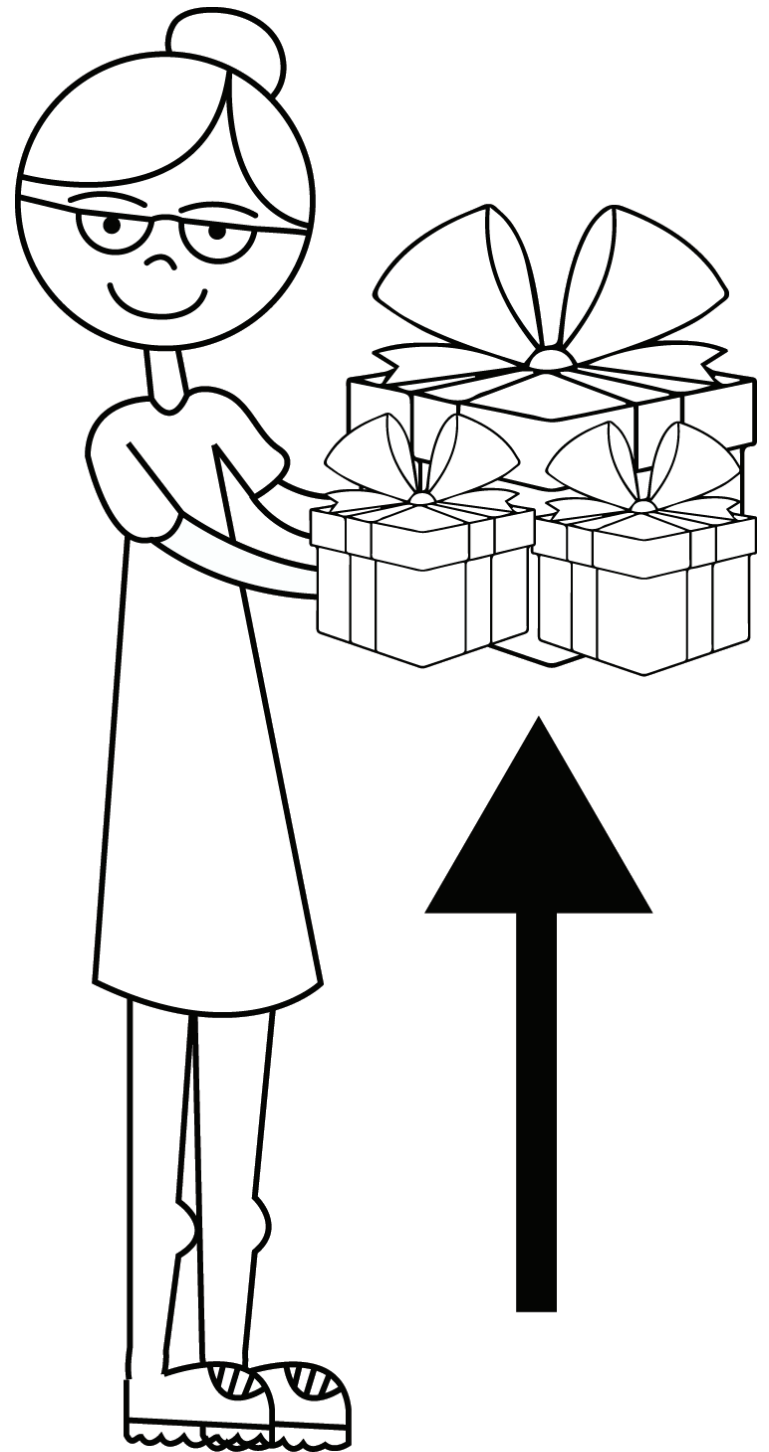

gift



carry

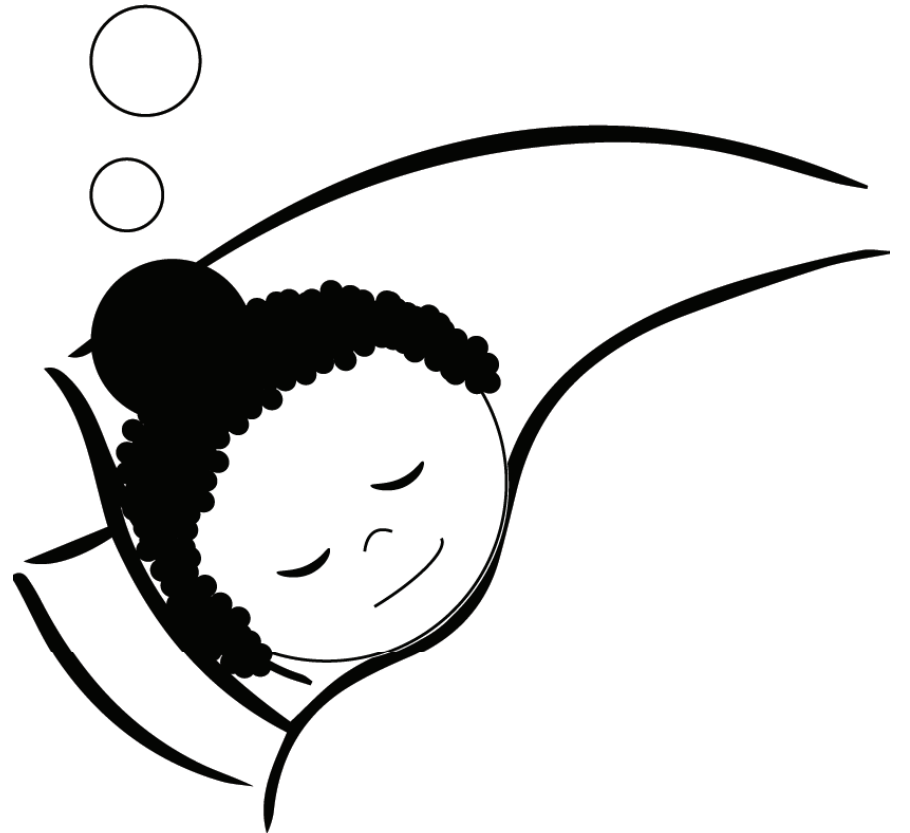
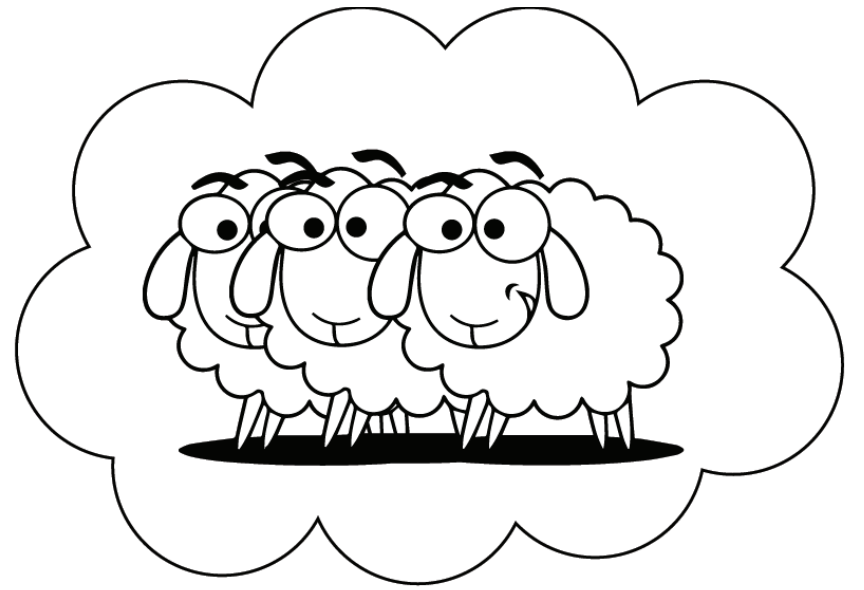

dream

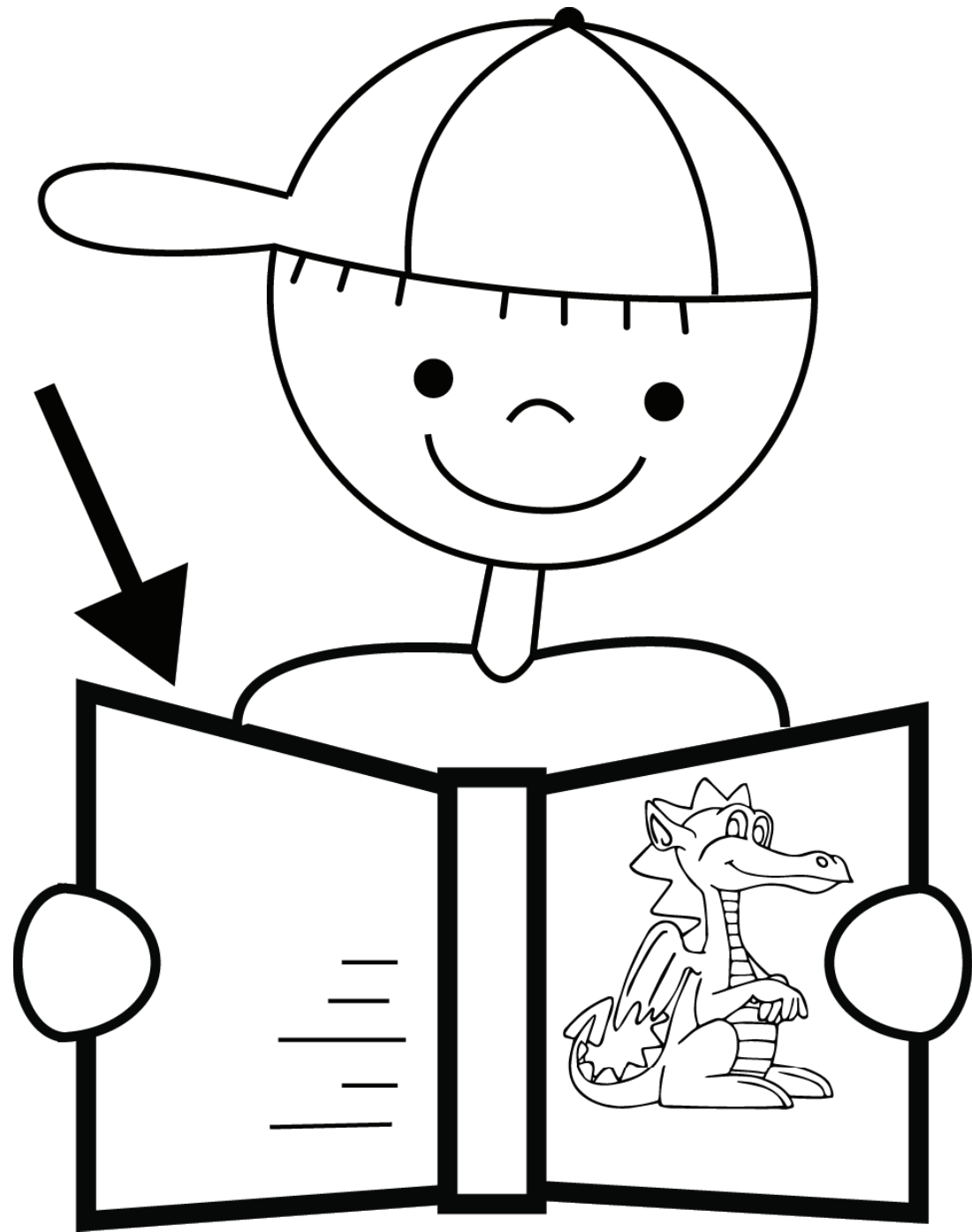

comics

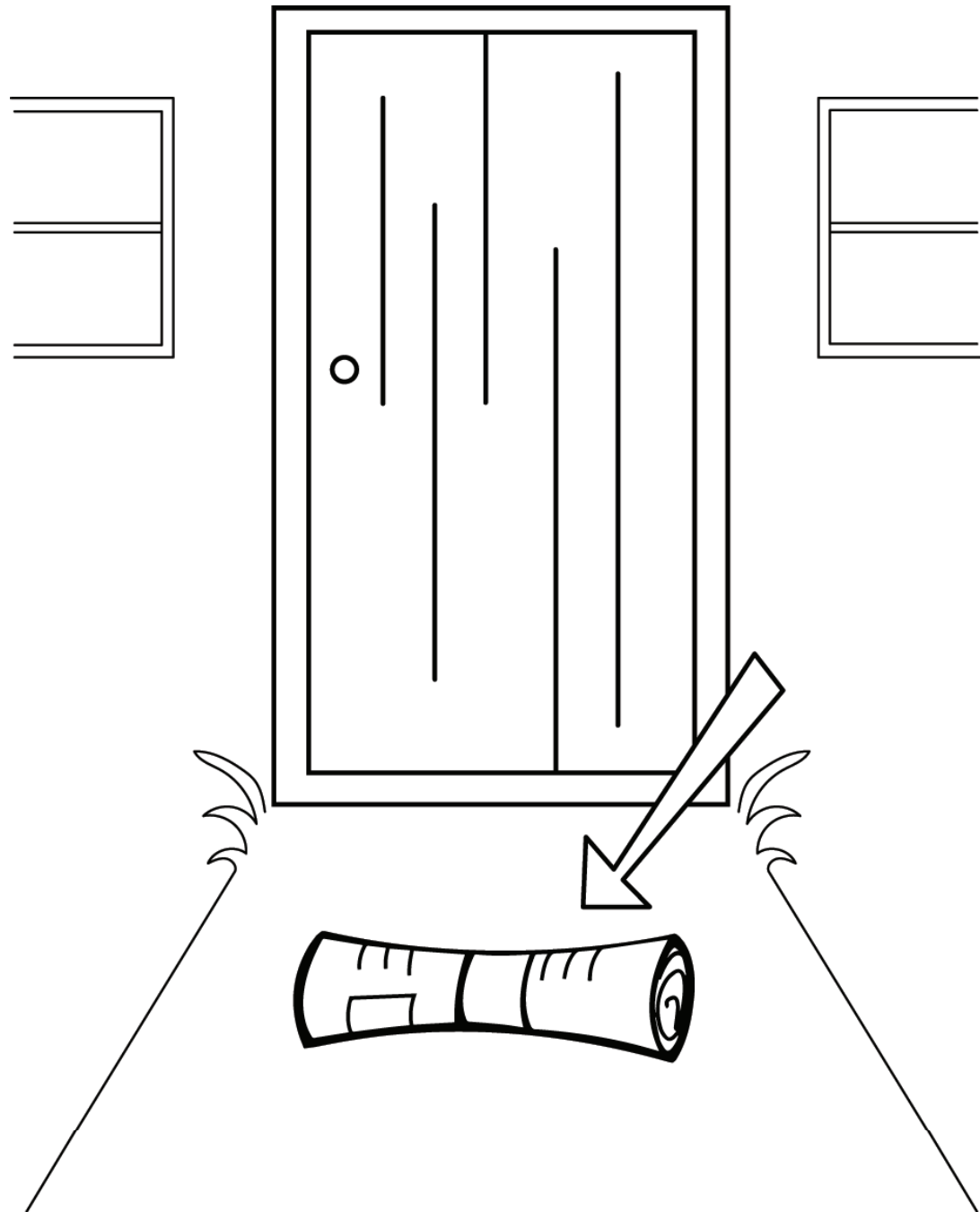

newspaper



story

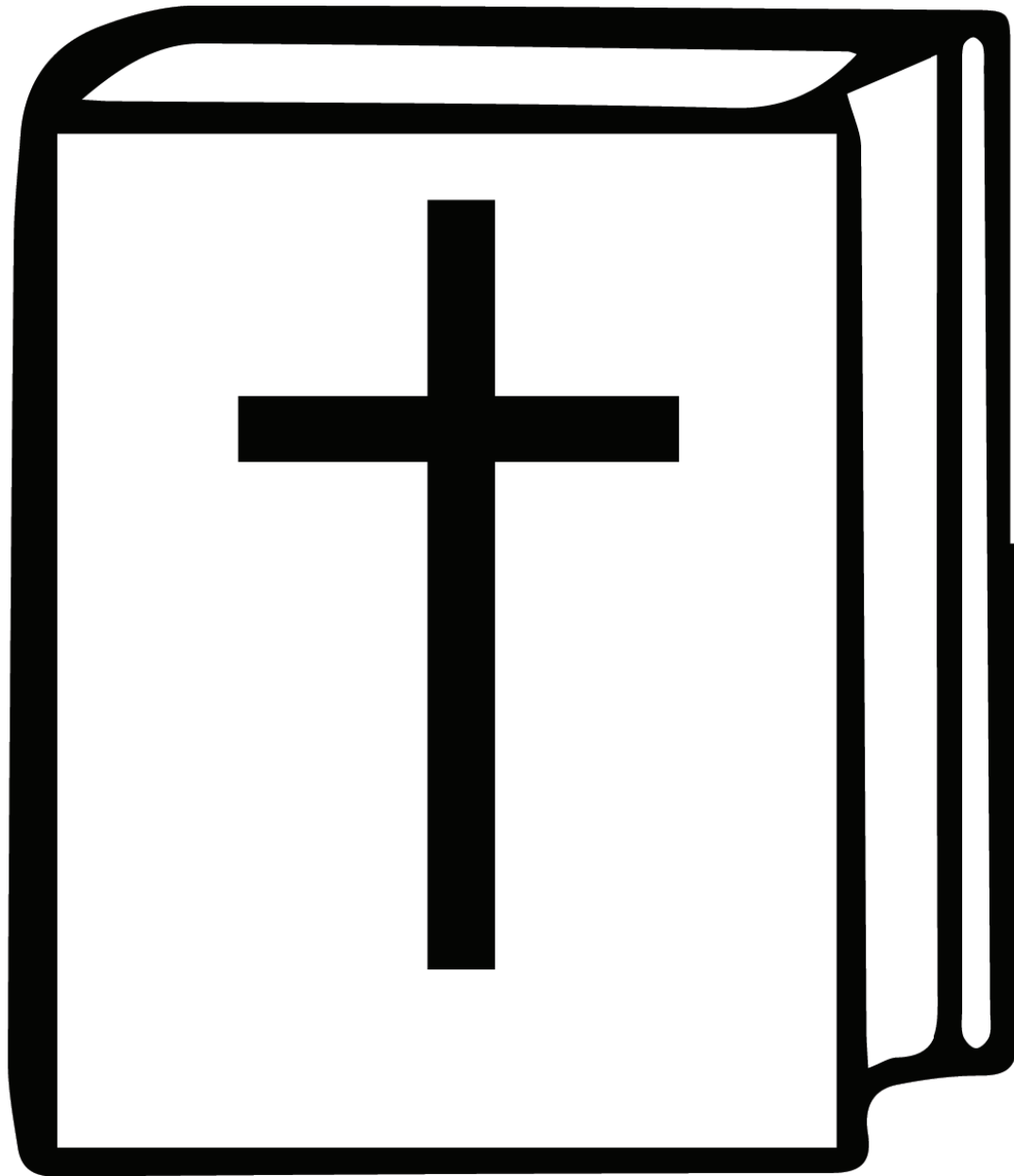

bible

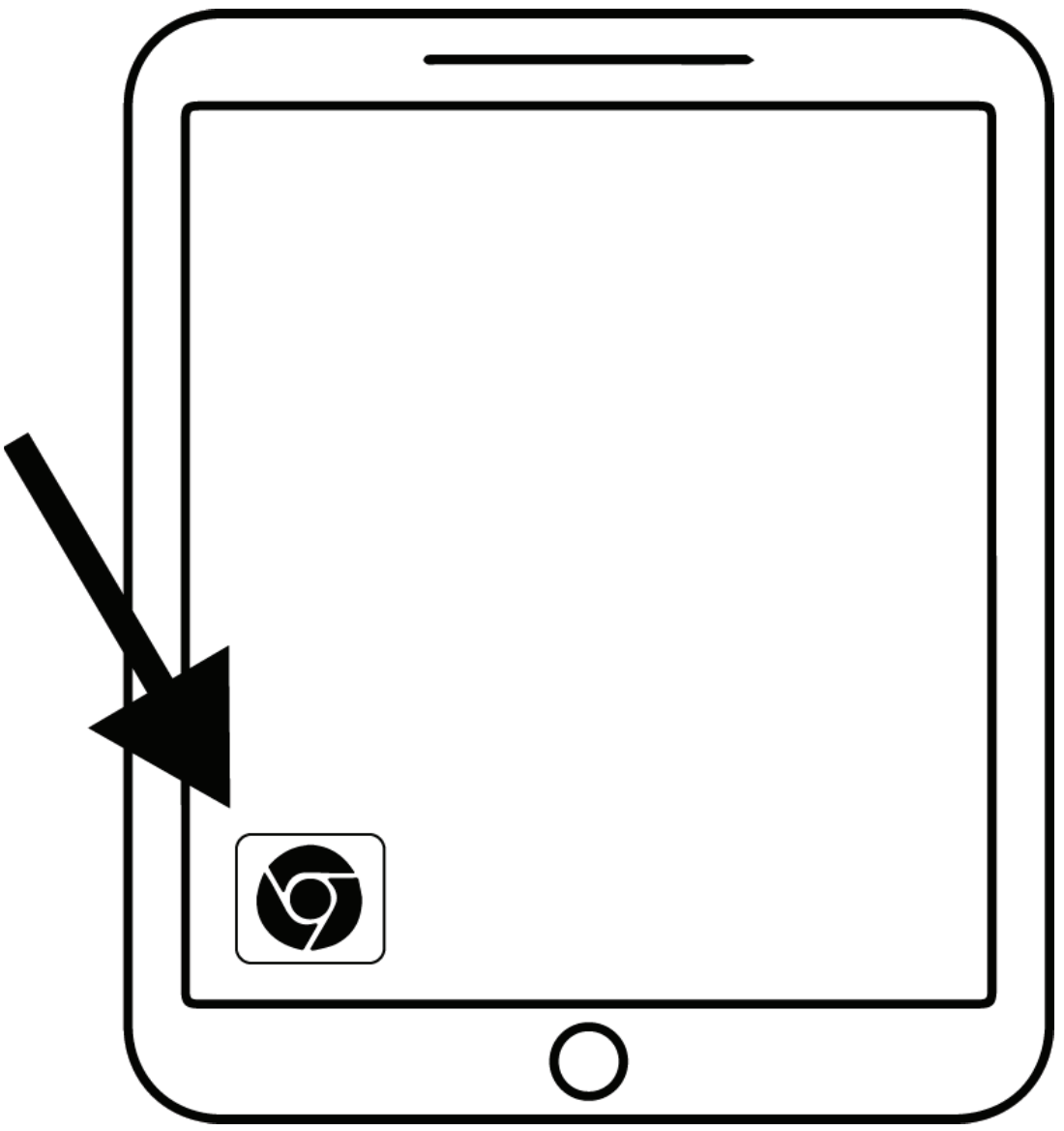

app

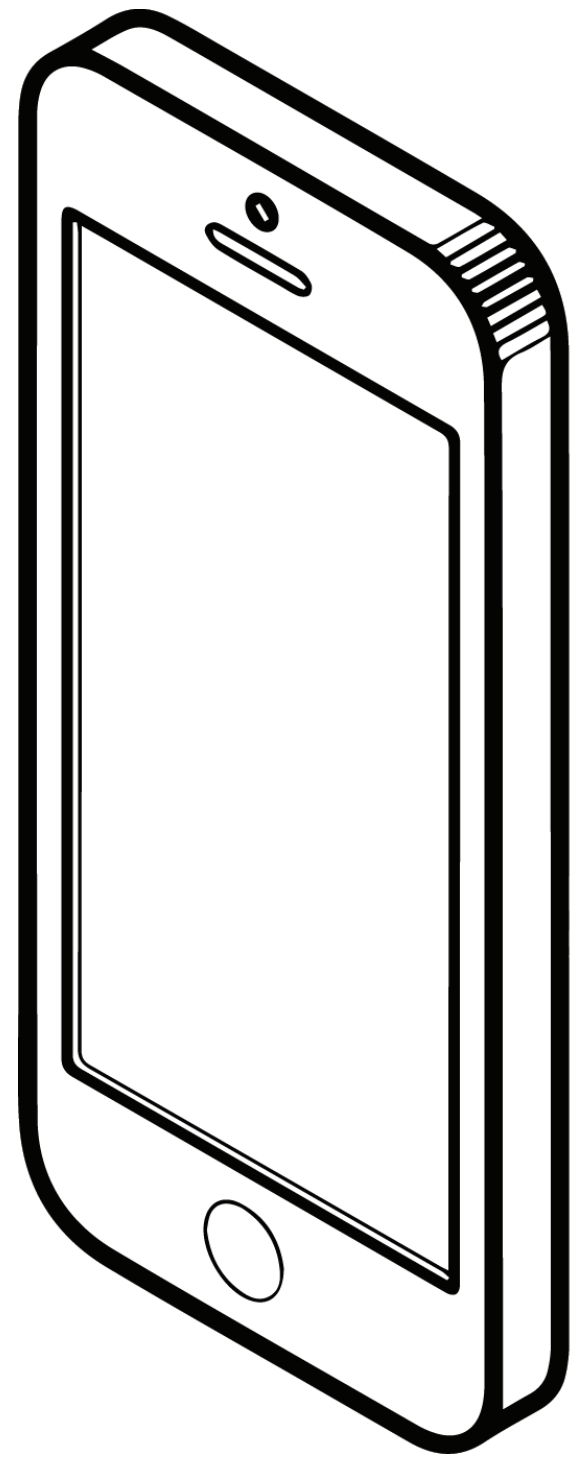

phone

Bleh!

Bleh!

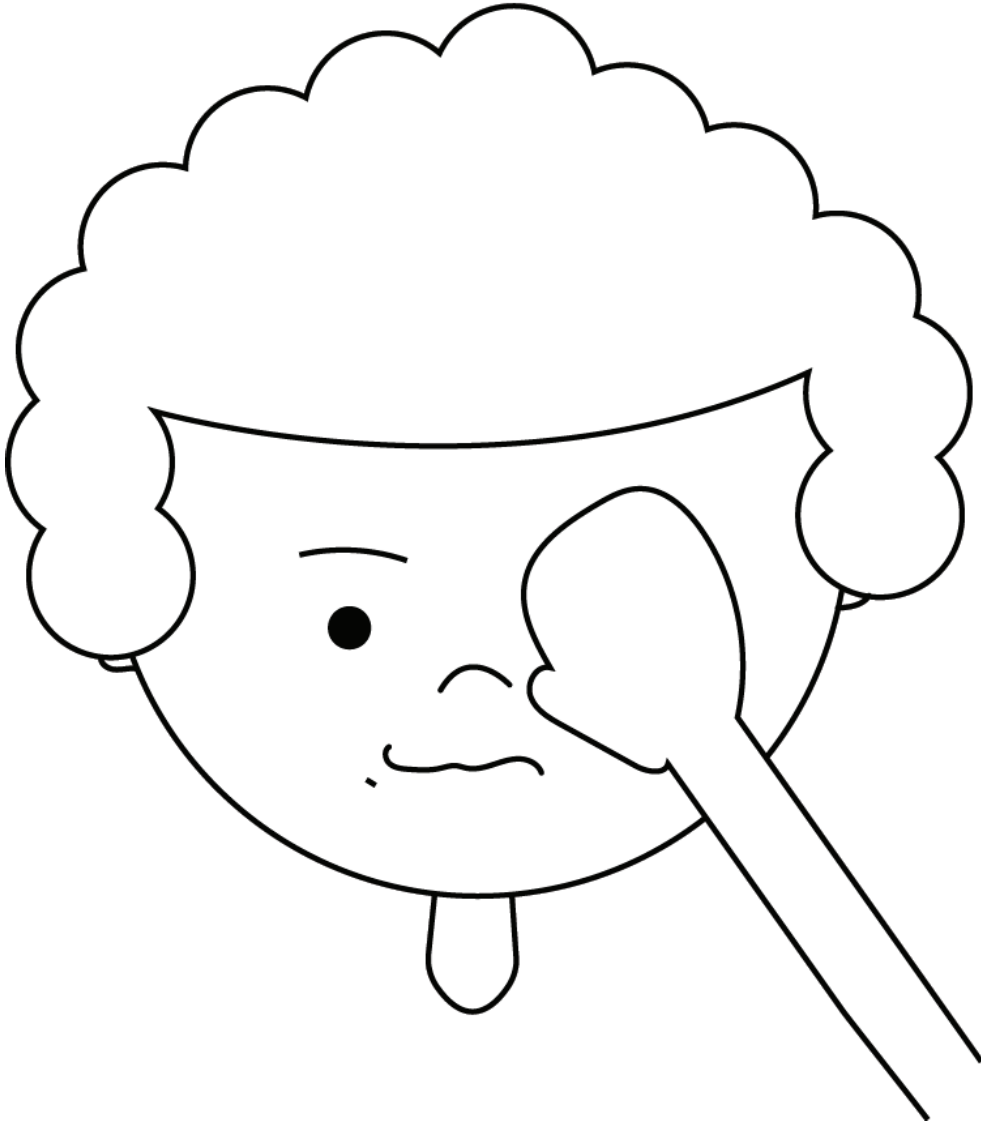

bored

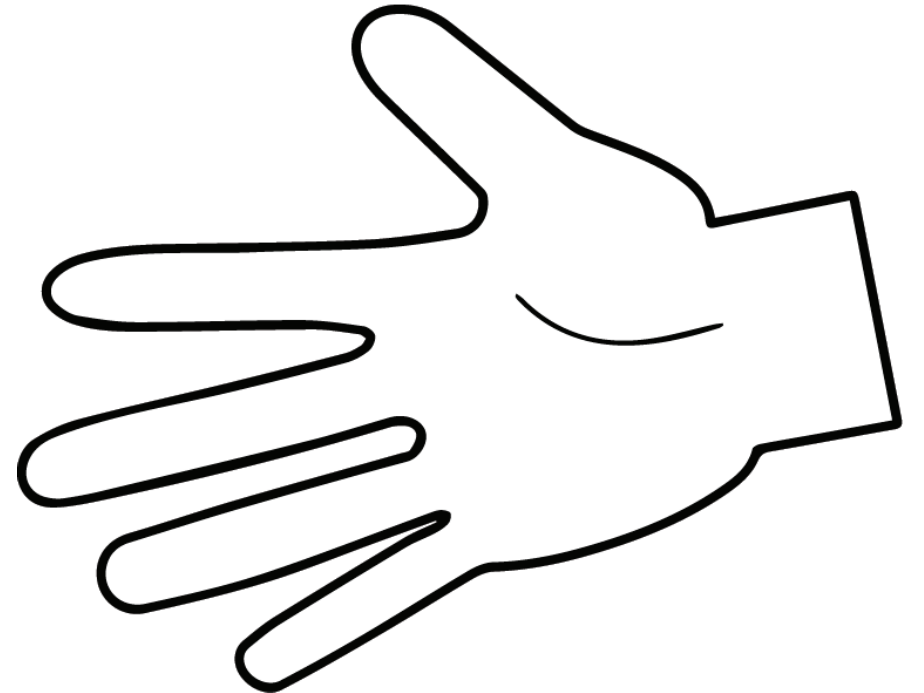
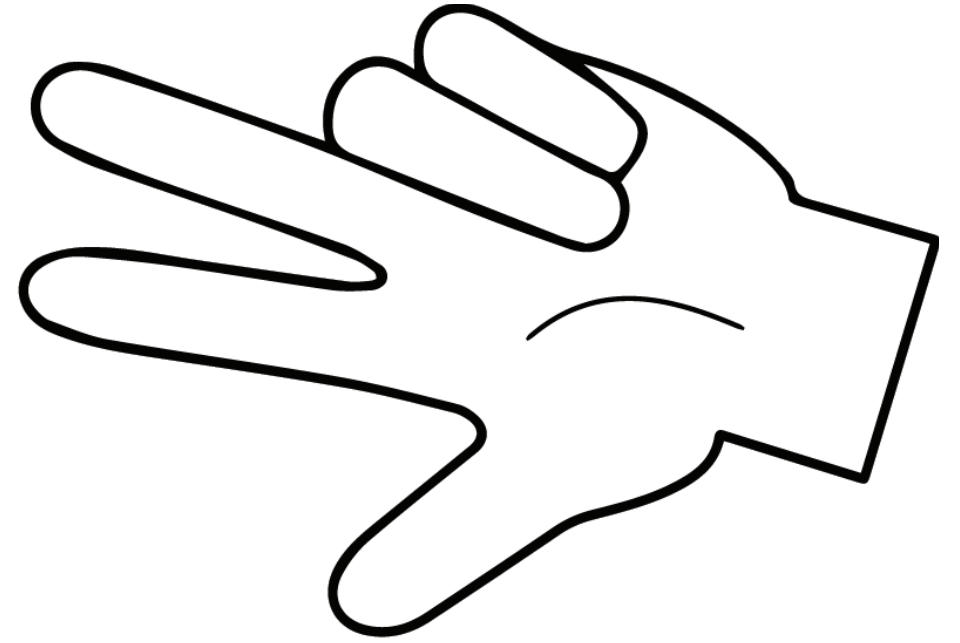

many

Eeeeeee!!

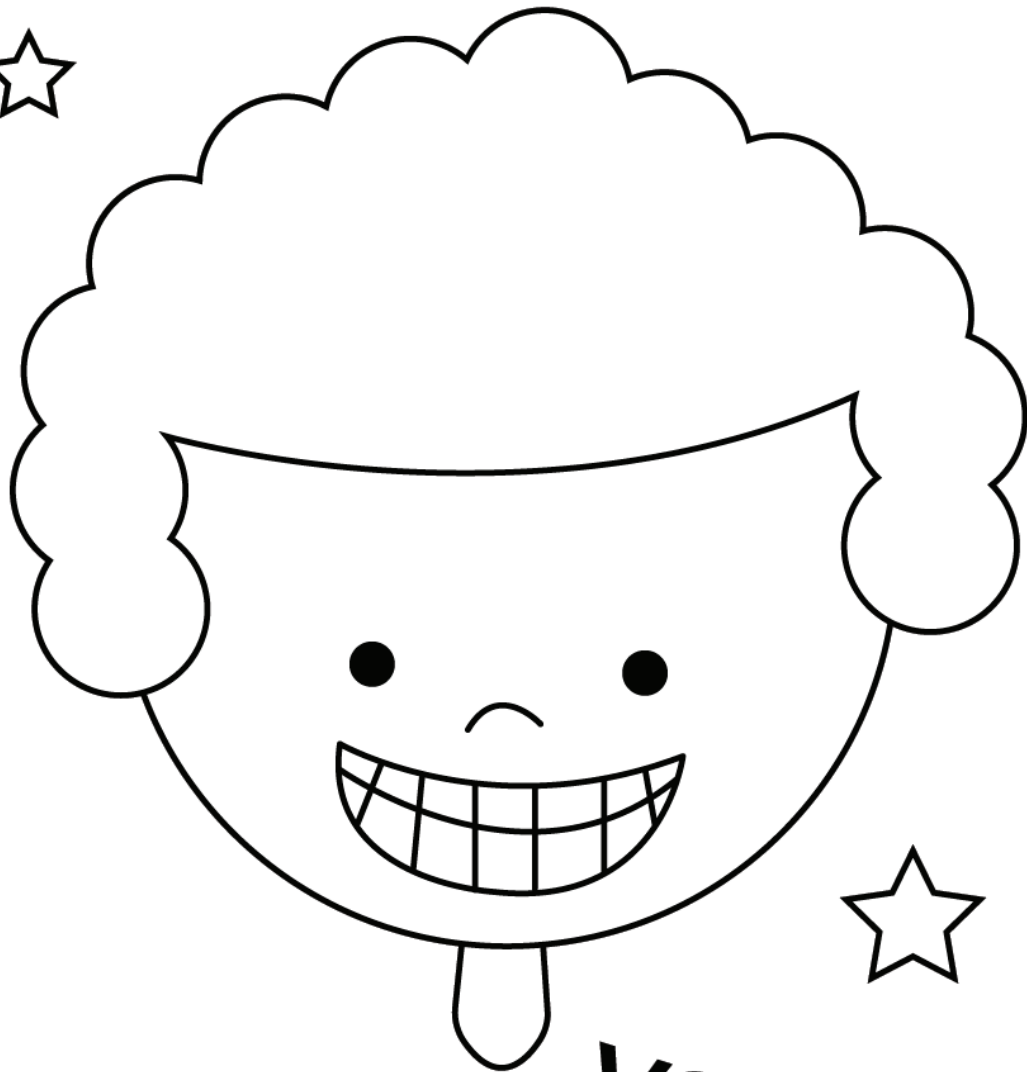

yay!!

exciting

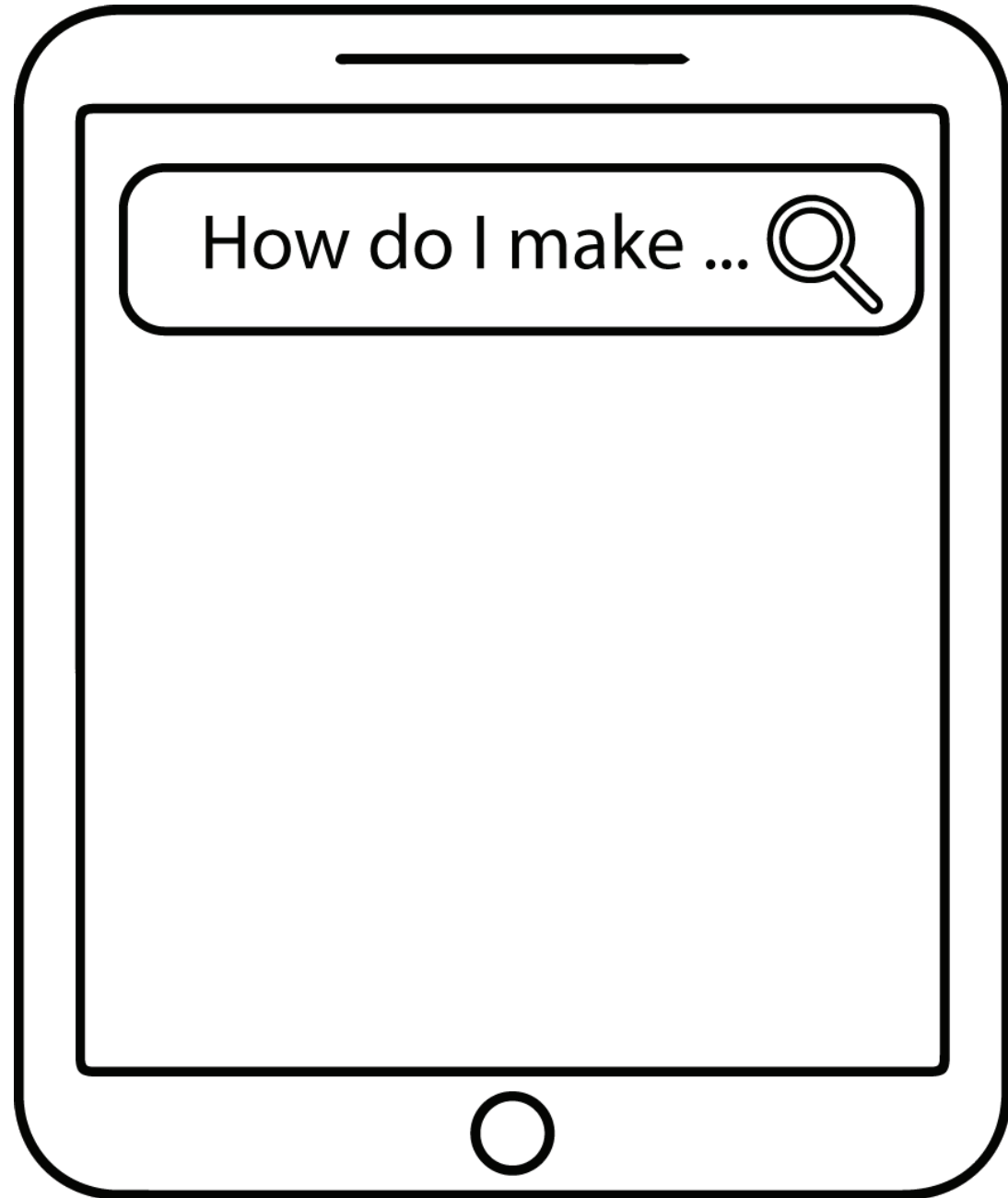

How do I make ...



search



aloud

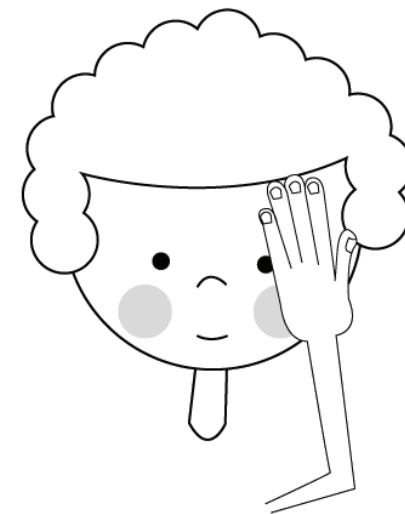
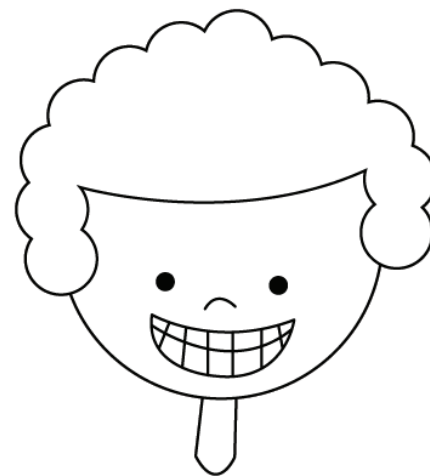
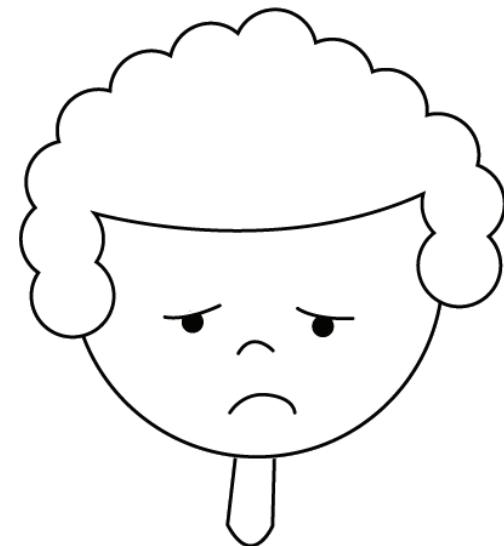
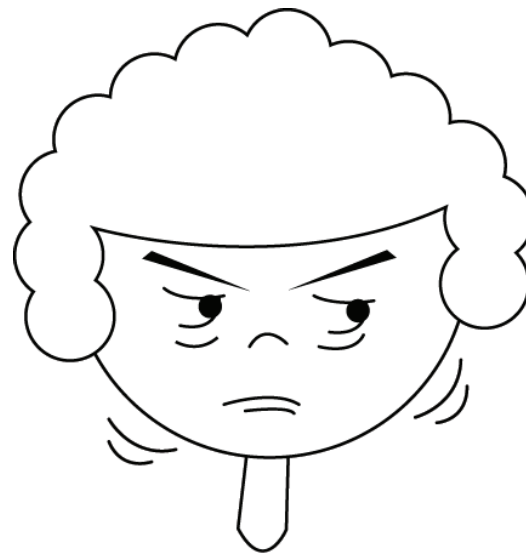

feeling

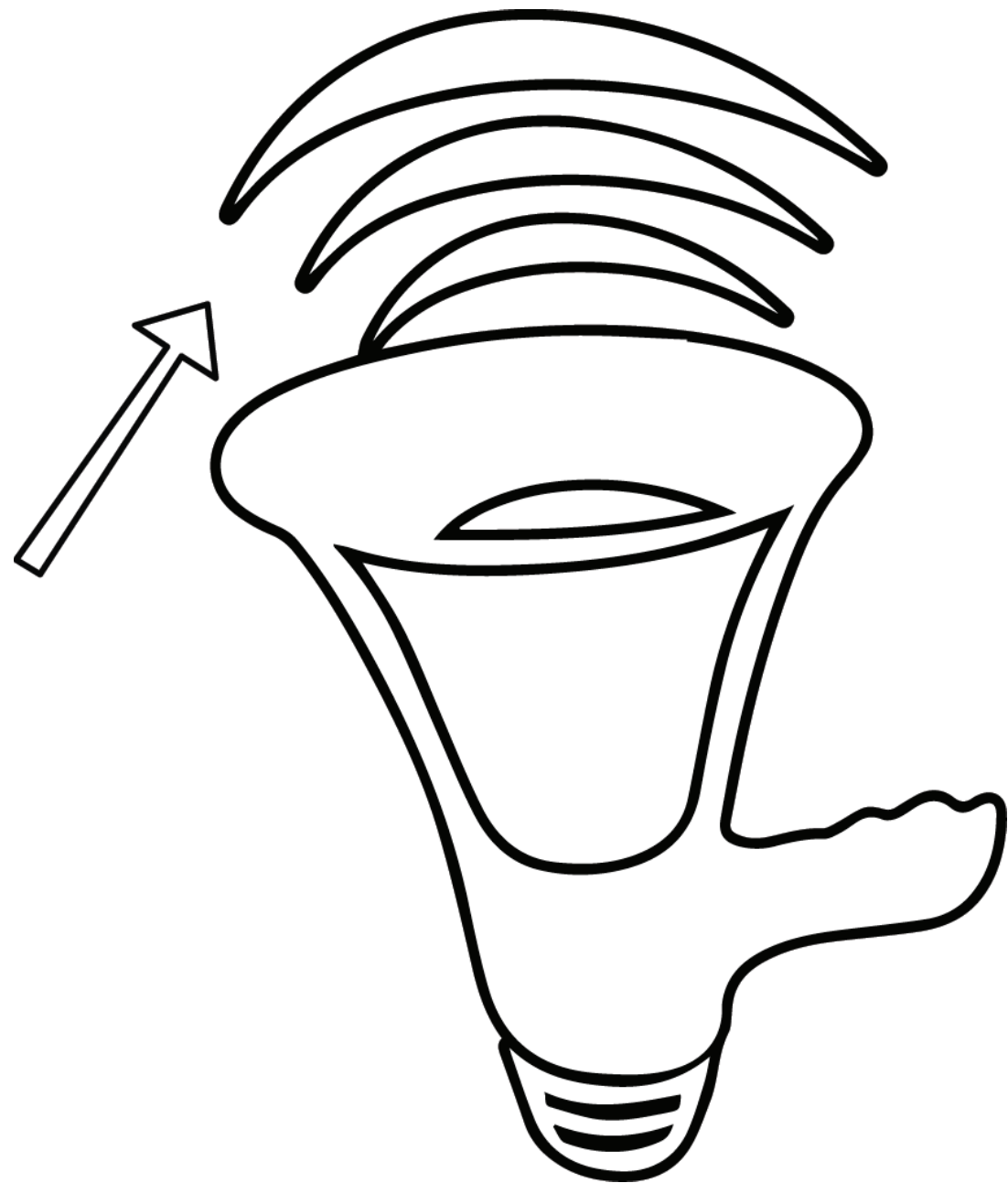

noise

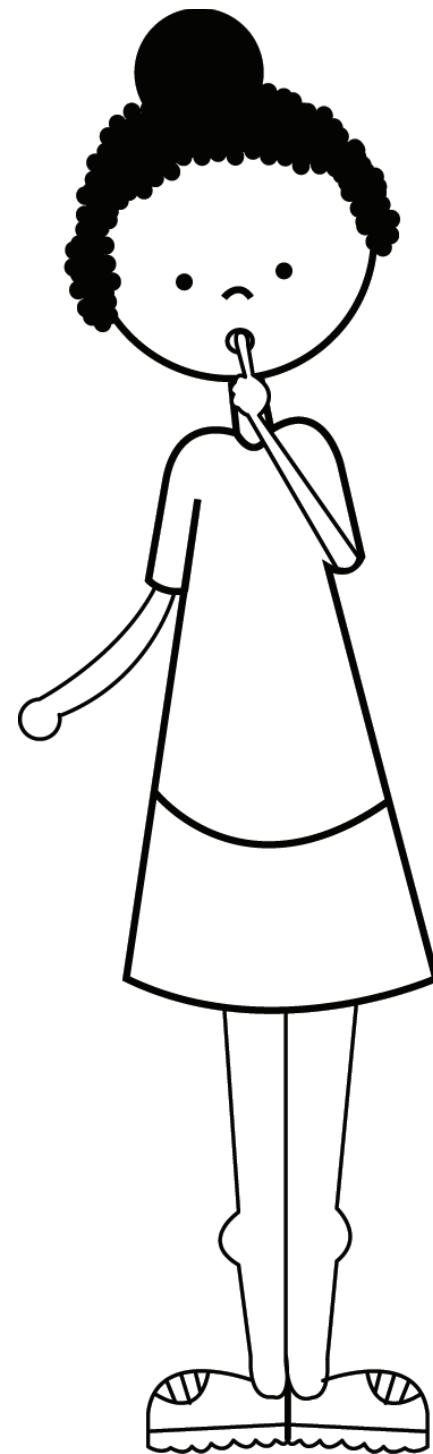

silent

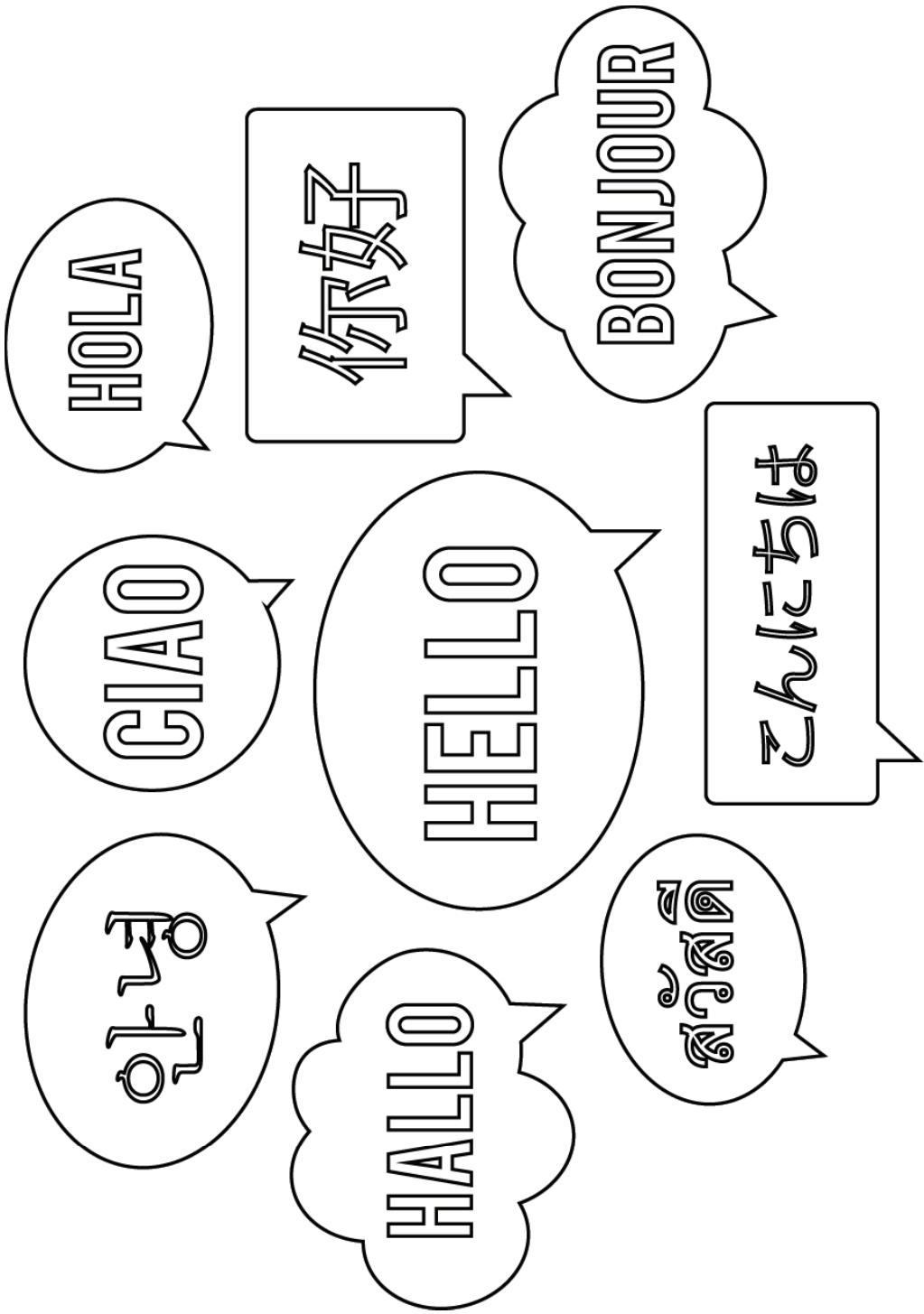

language

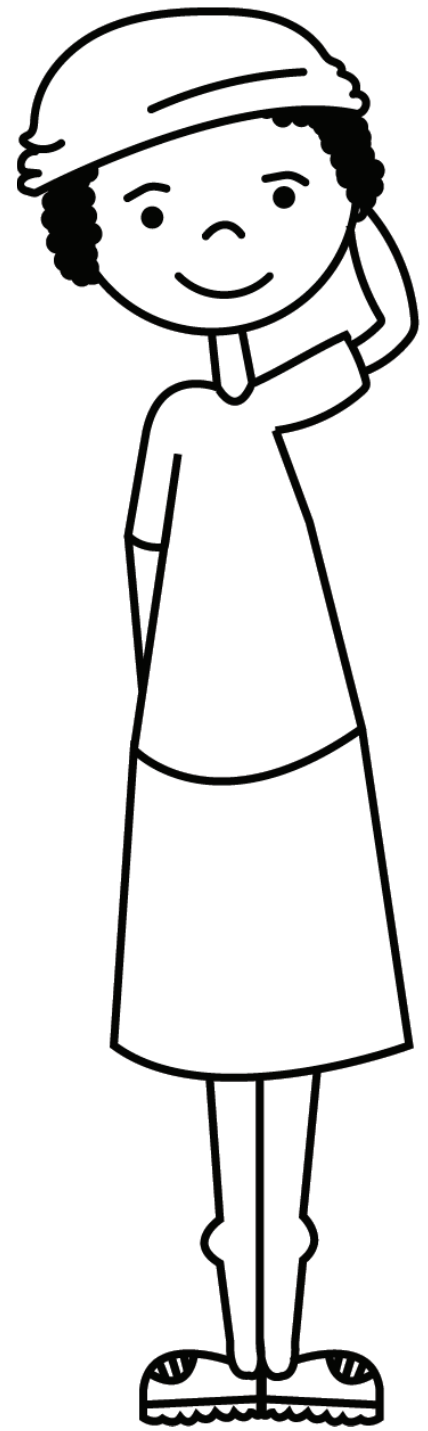

listen

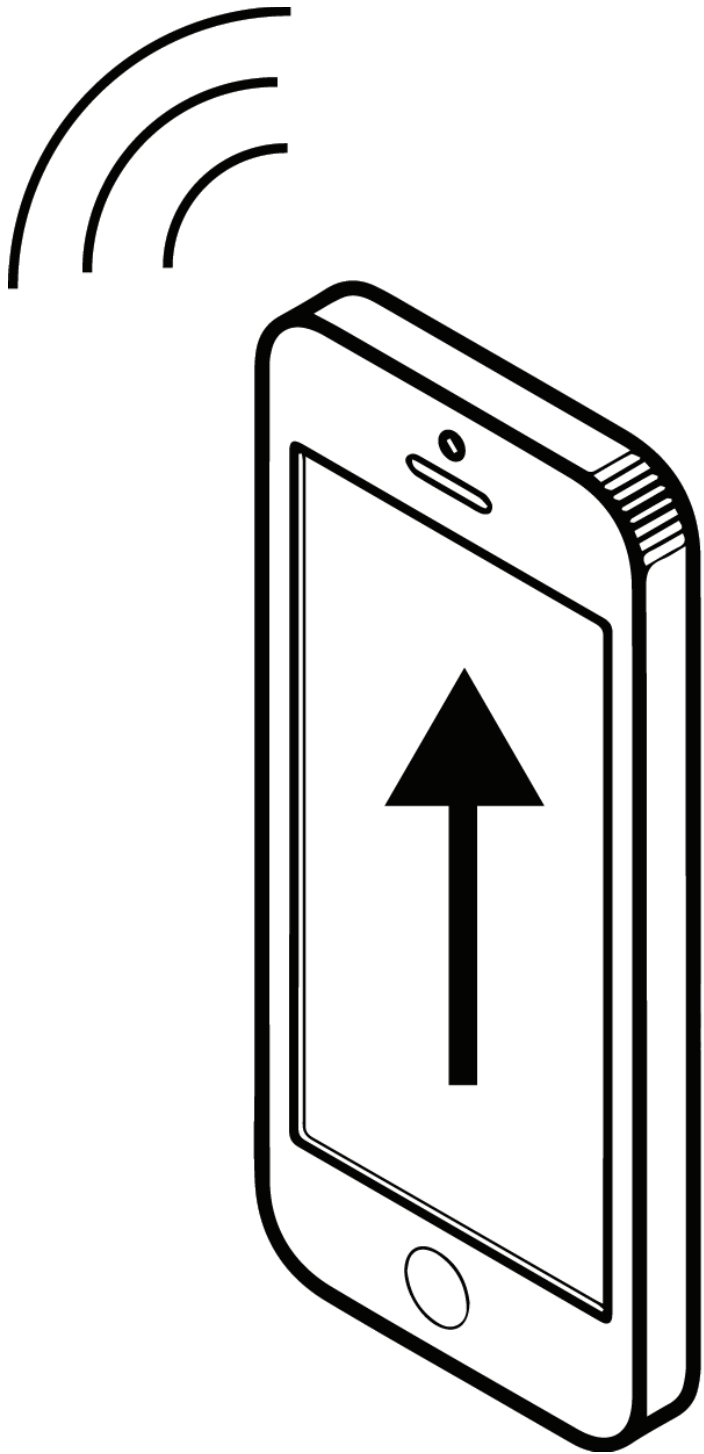

airtime



shout

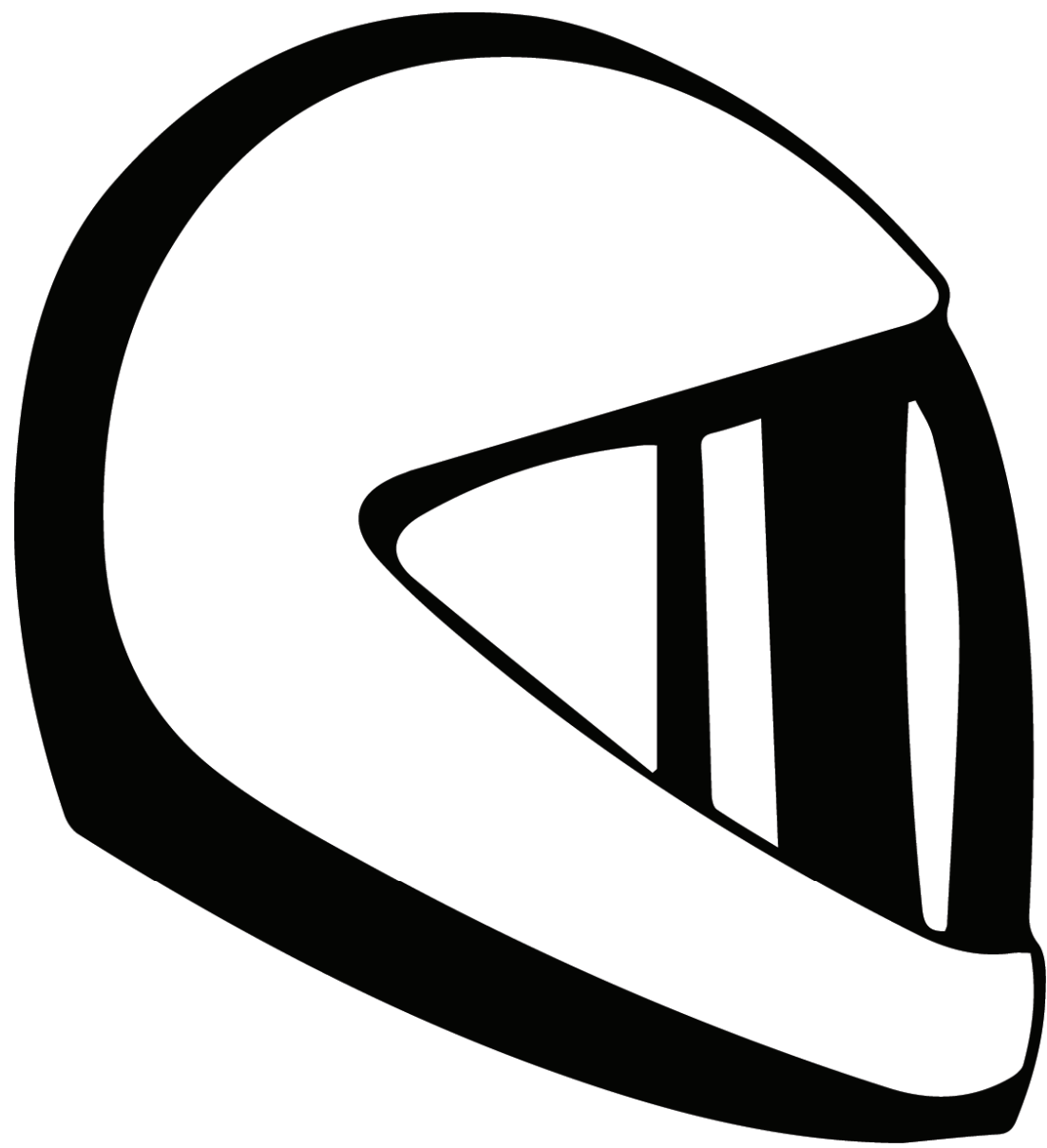

helmet

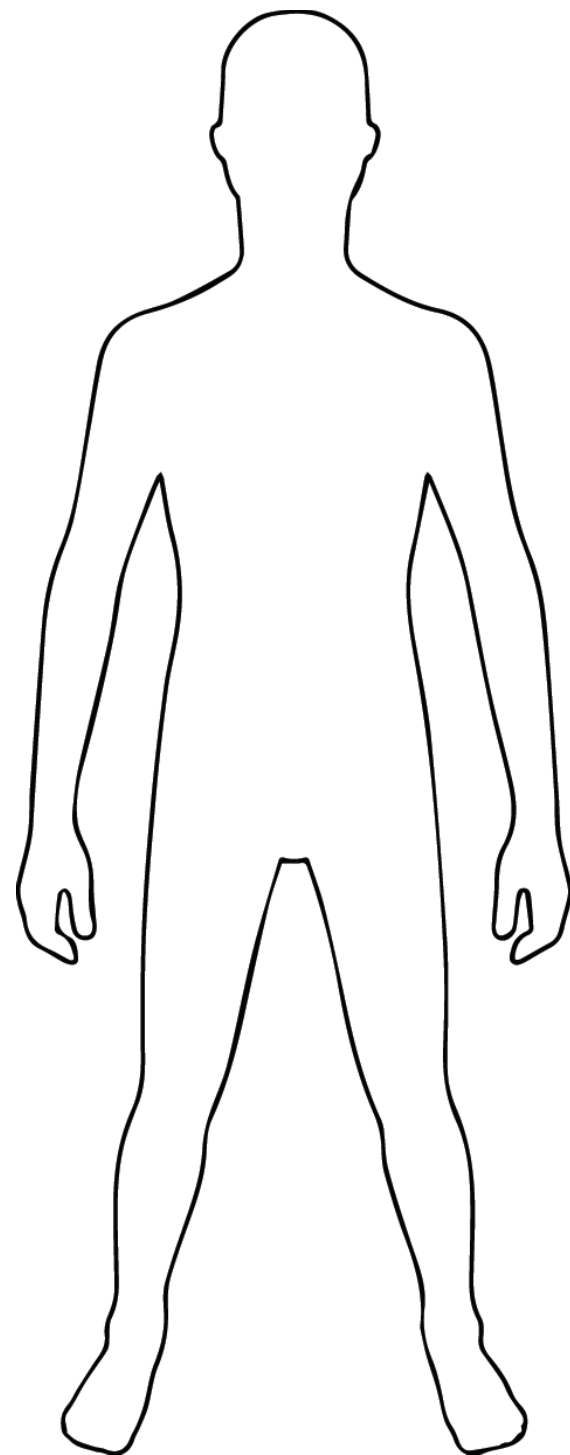

body

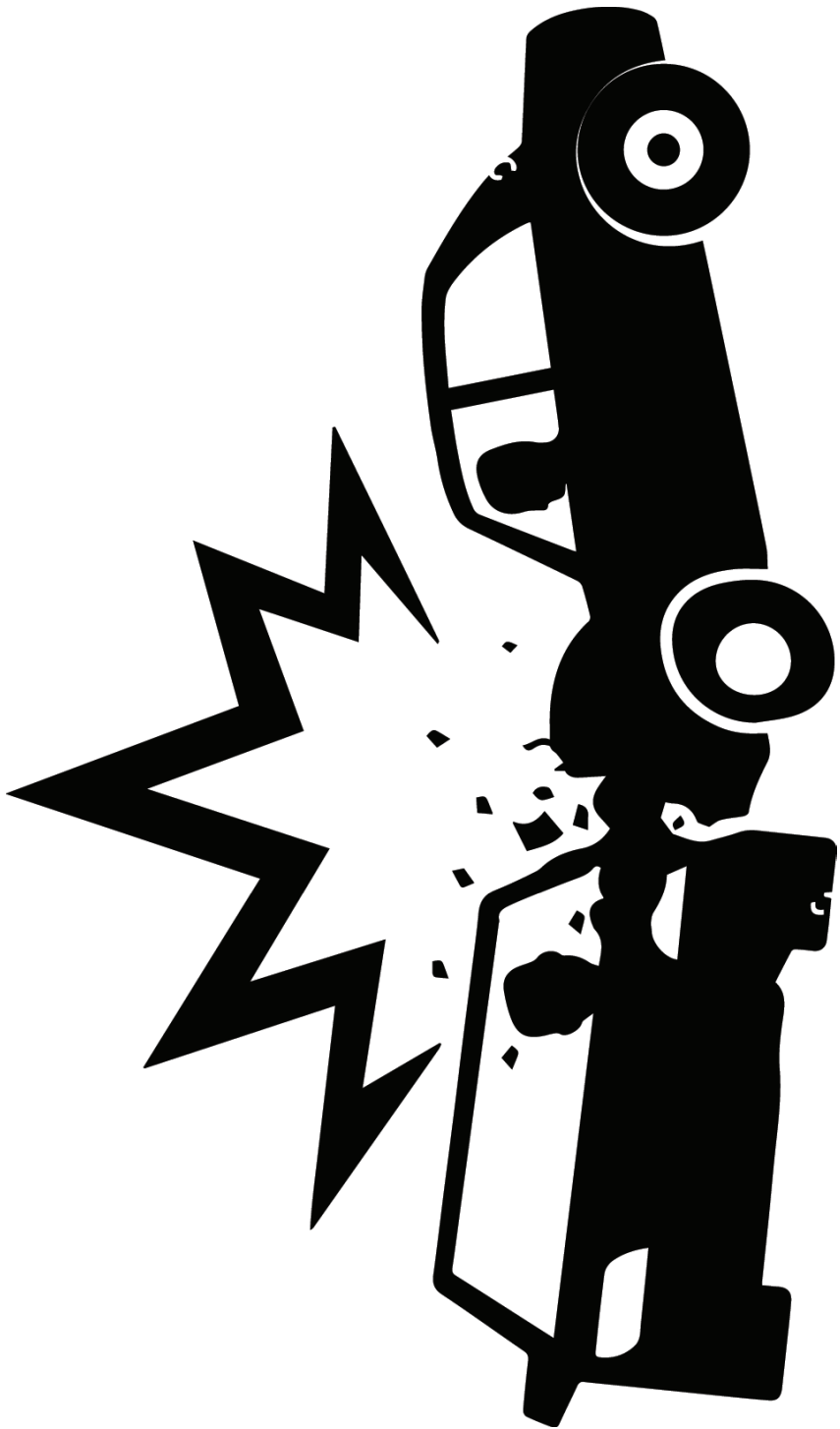

crash

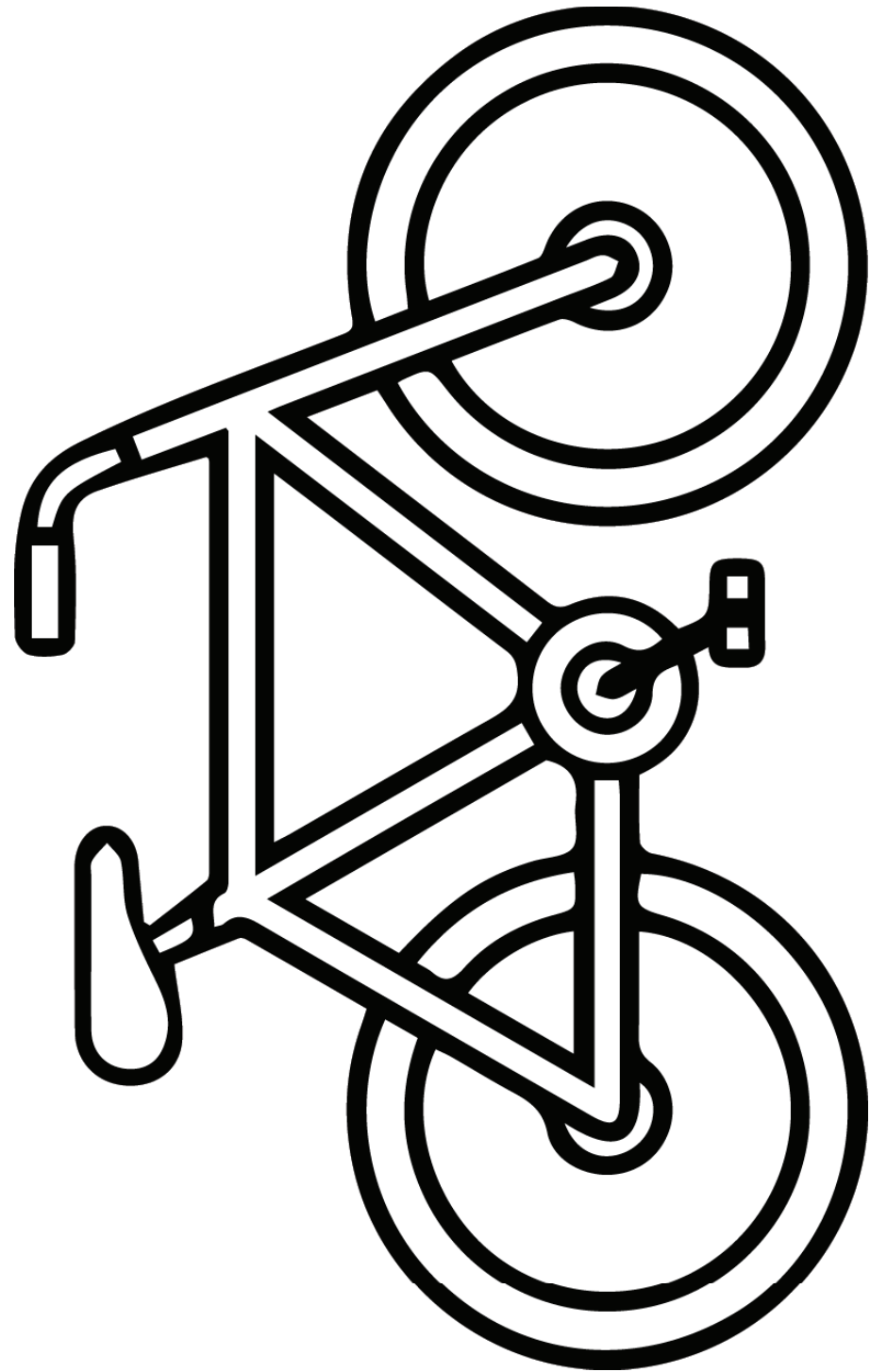

bicycle

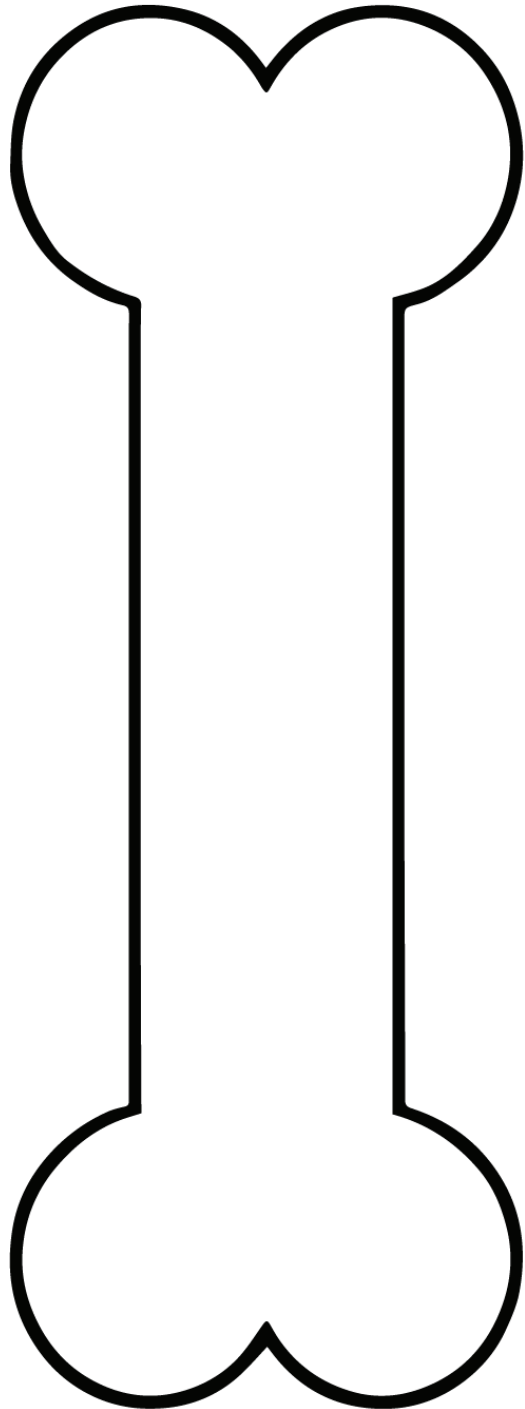

bone

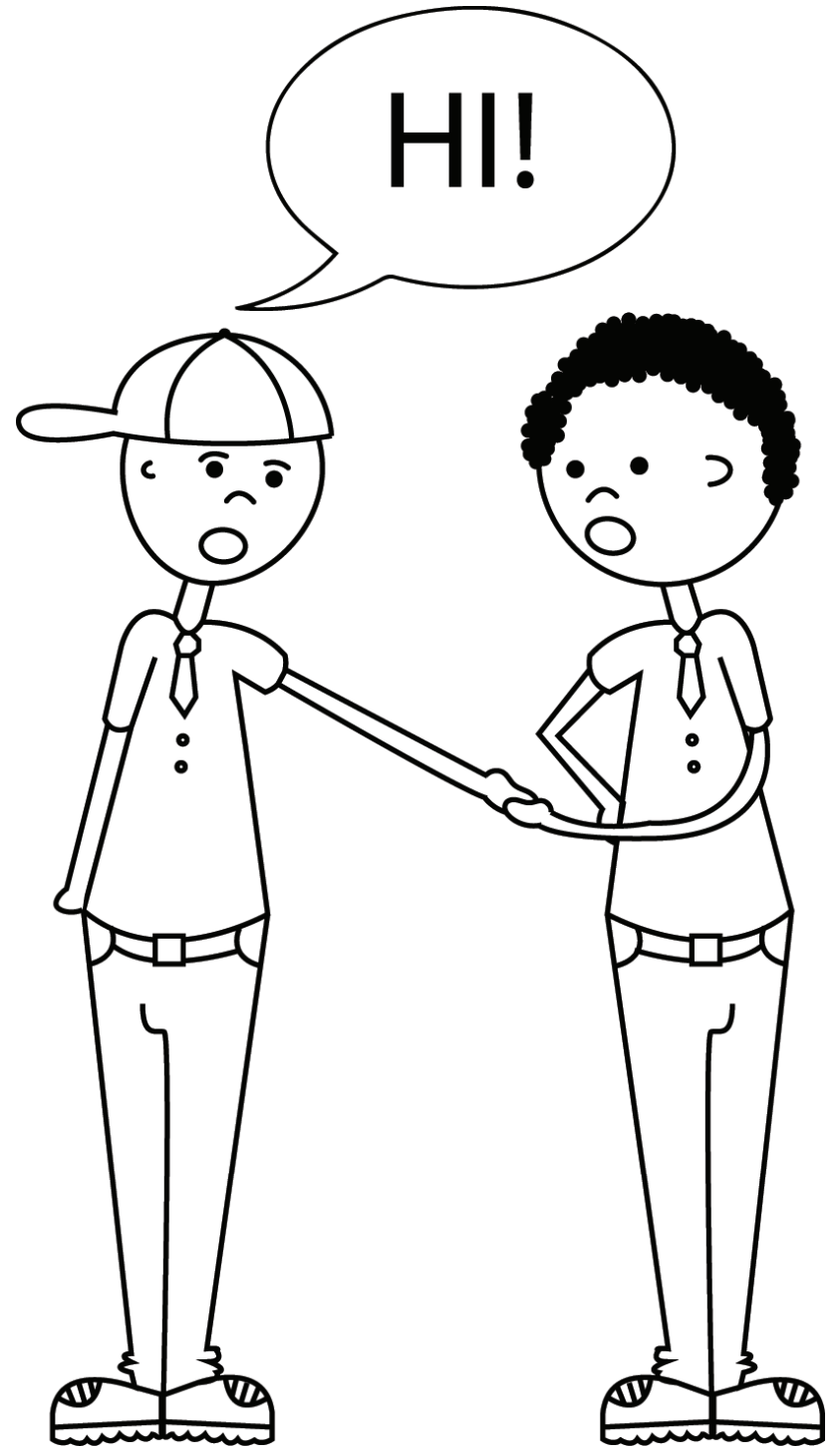

greet

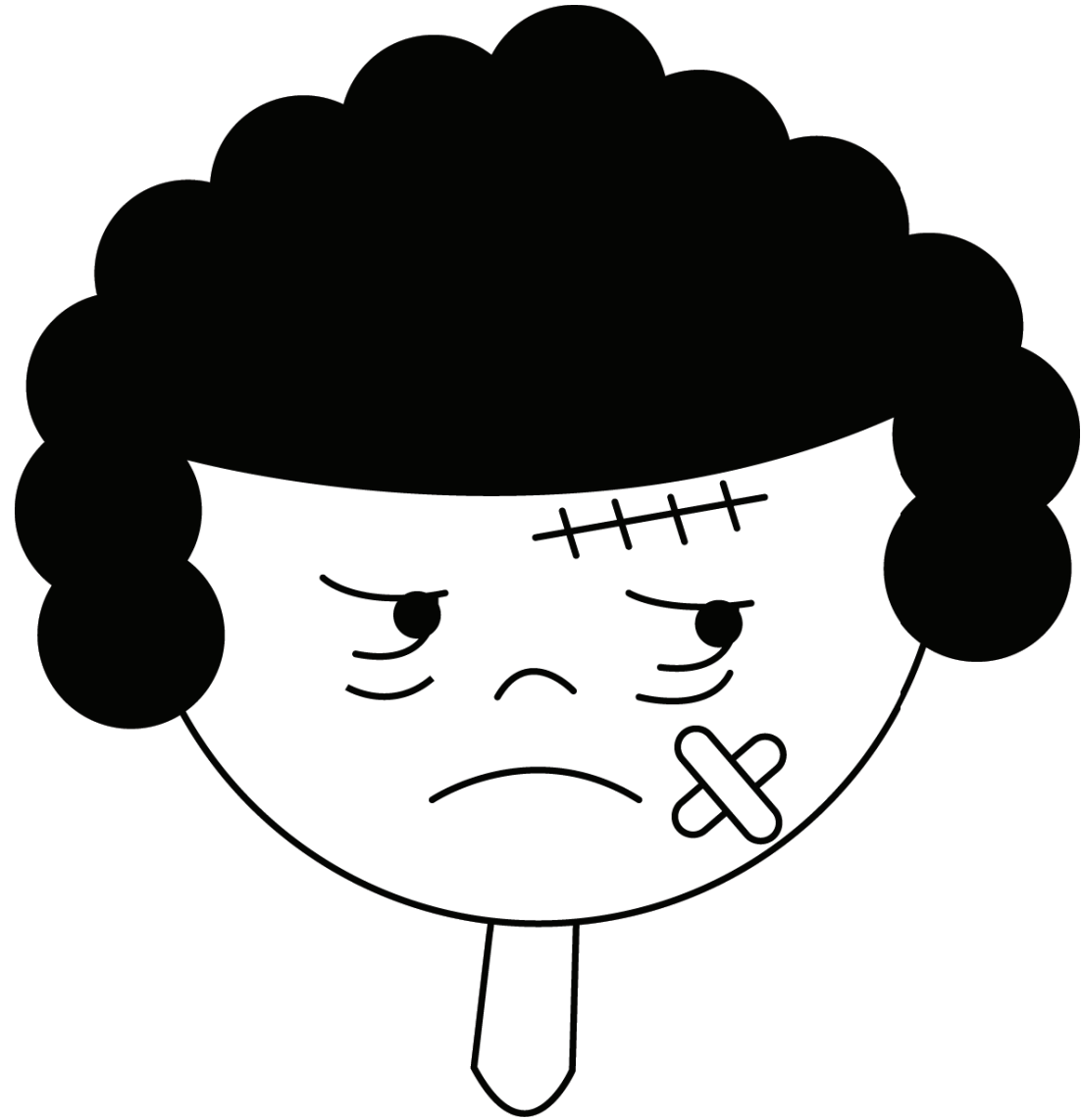

hurt

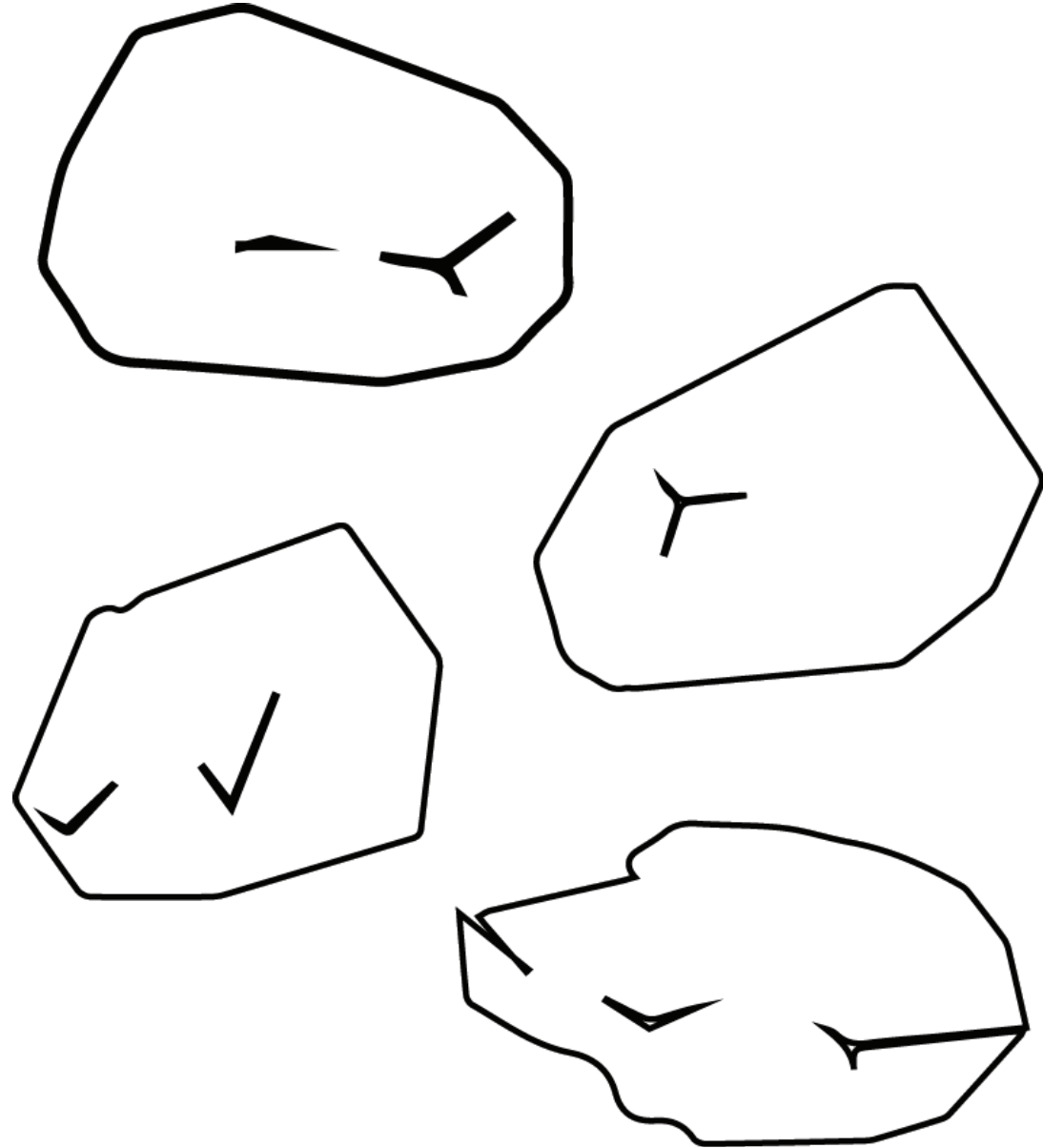

rock



fall

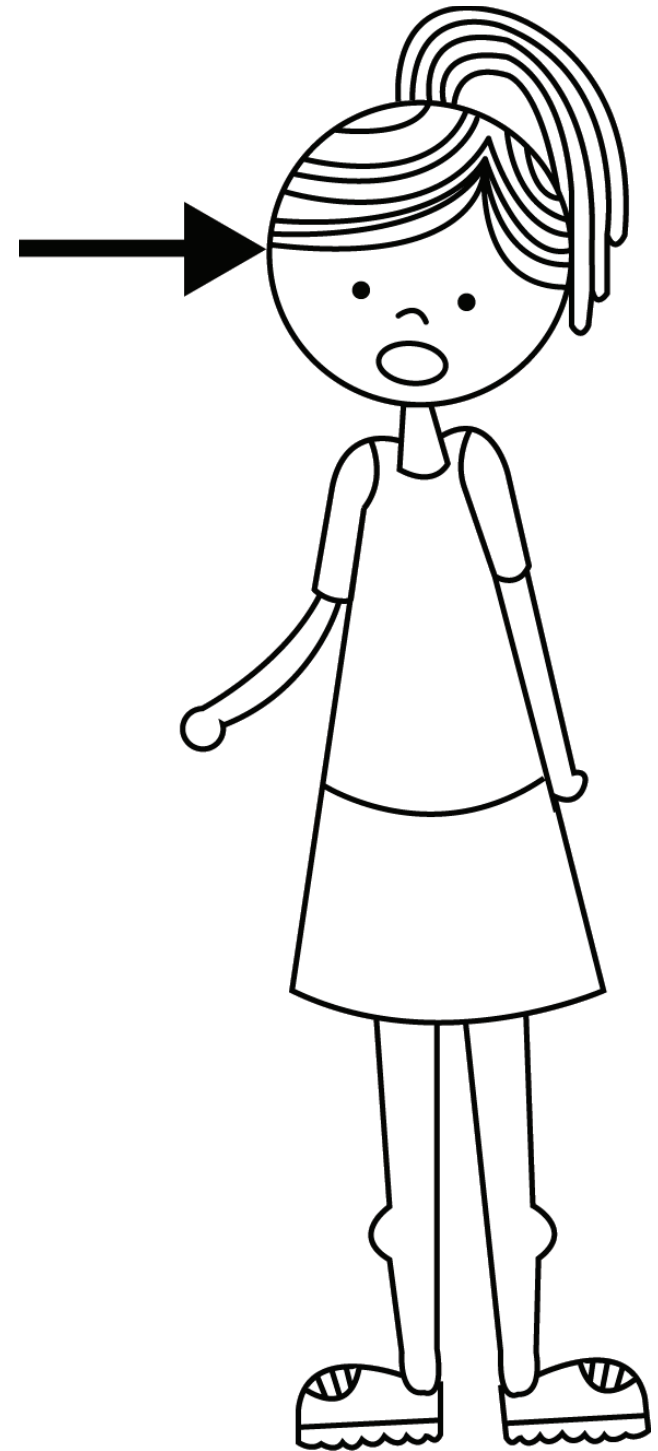

head



wash

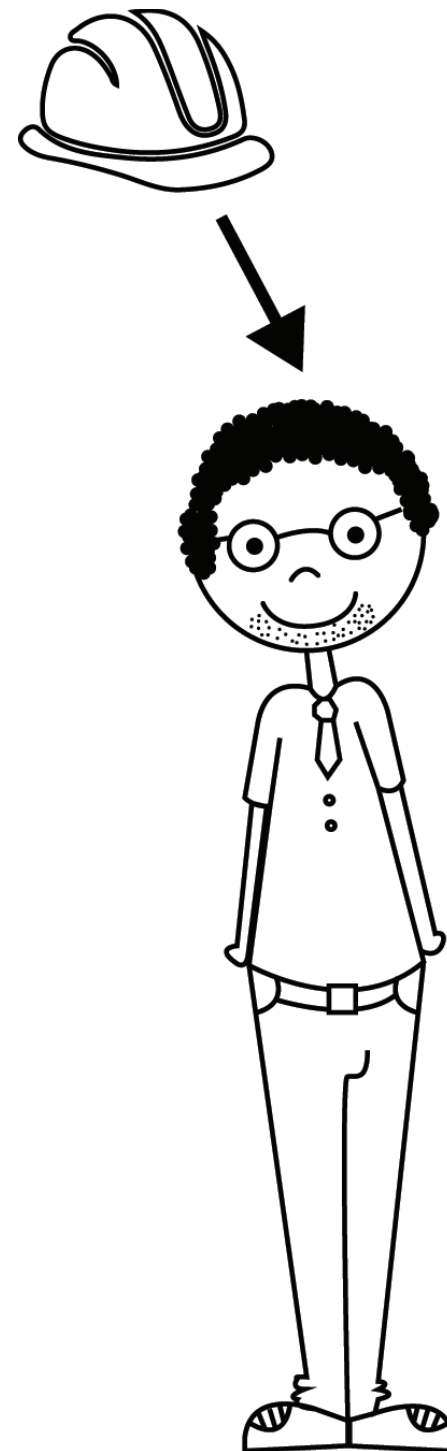

protect

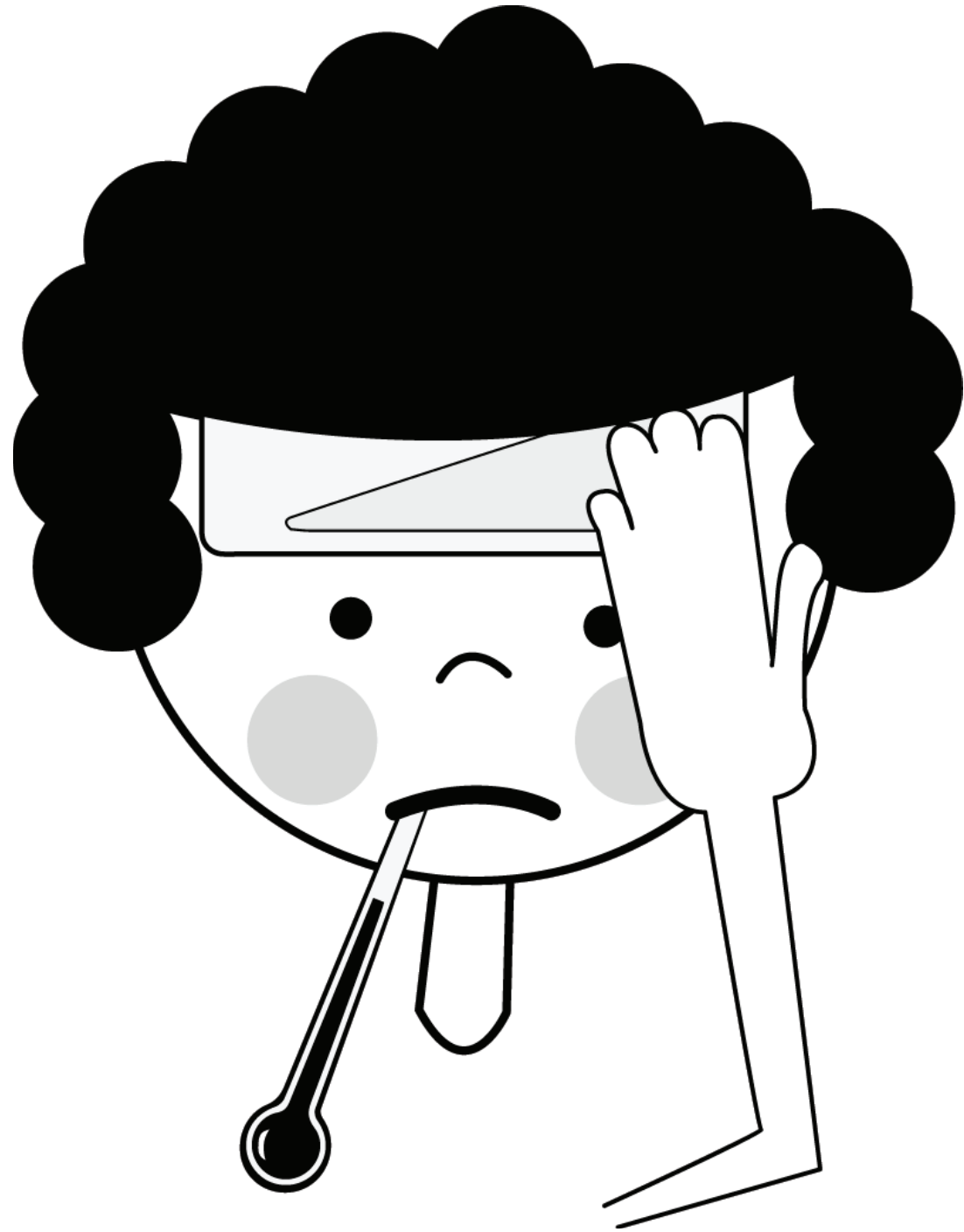

sick

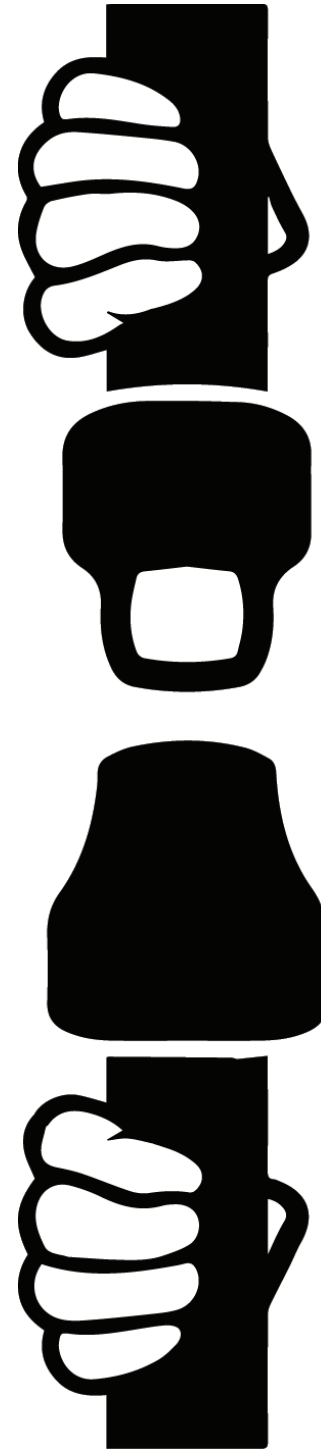

seatbelt



sleep

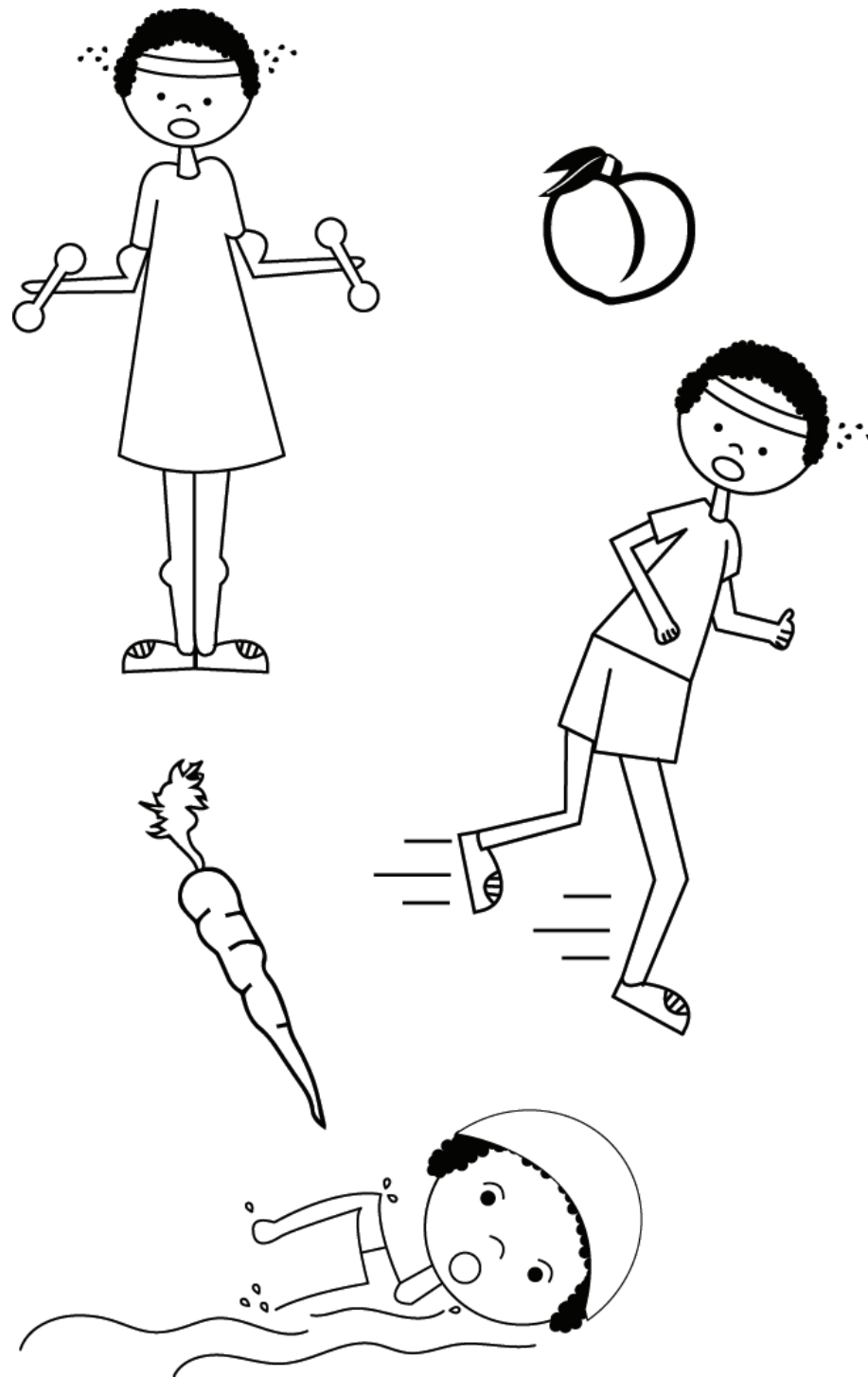

healthy

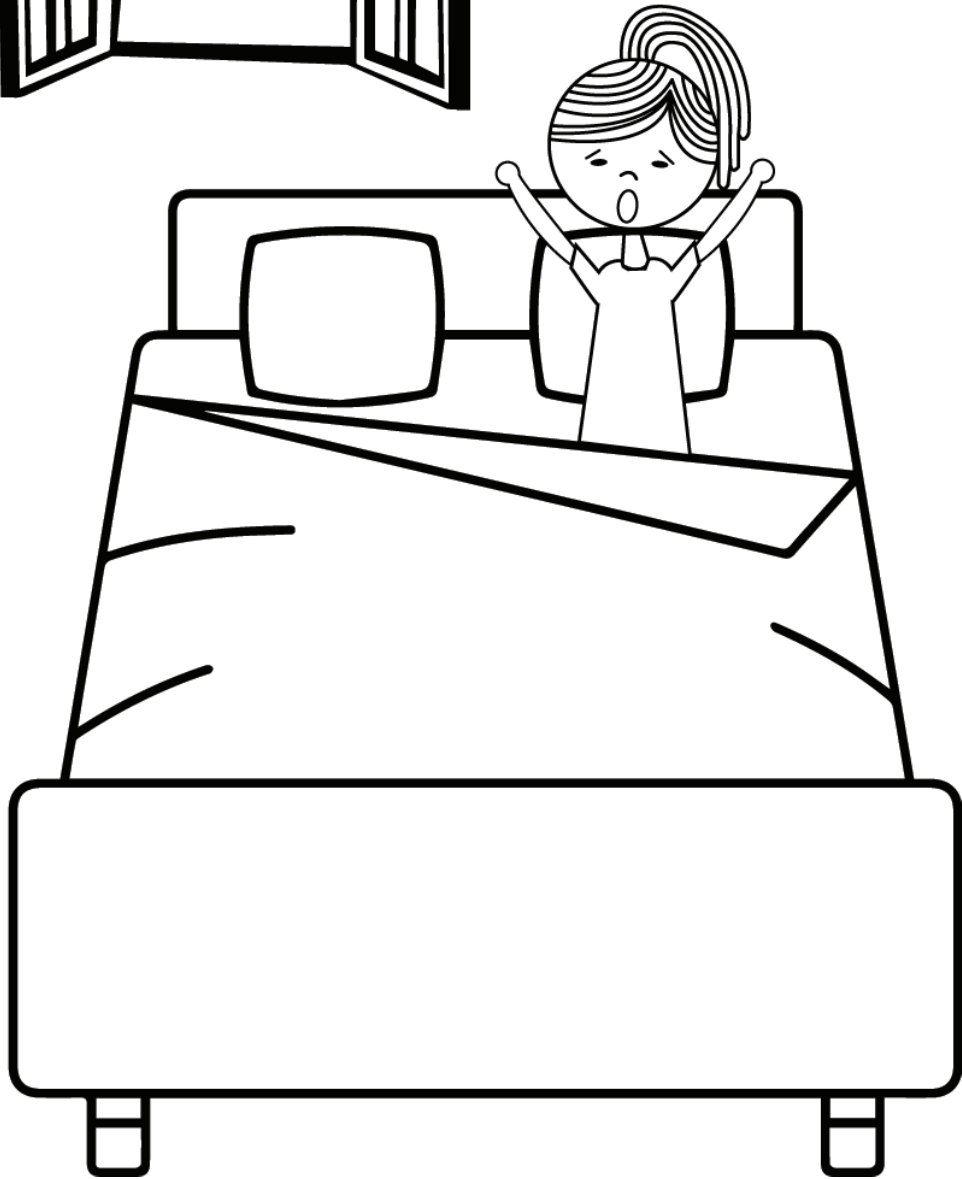
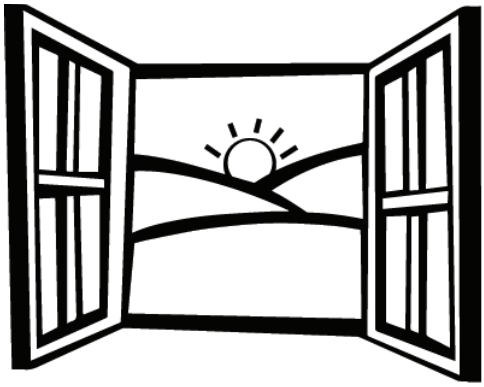

awake

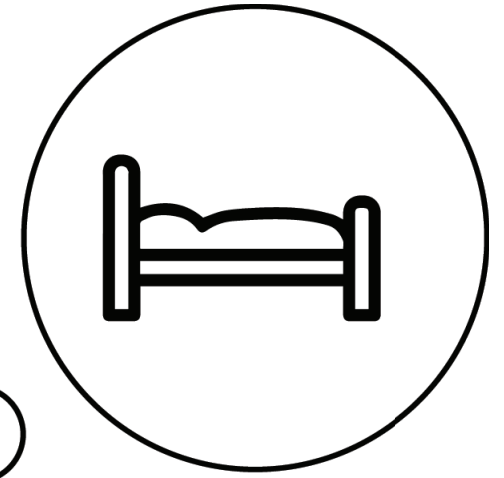
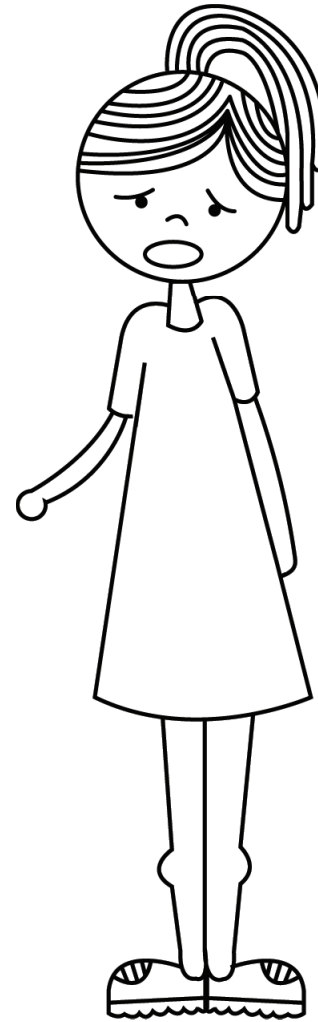

tired



uncomfortable

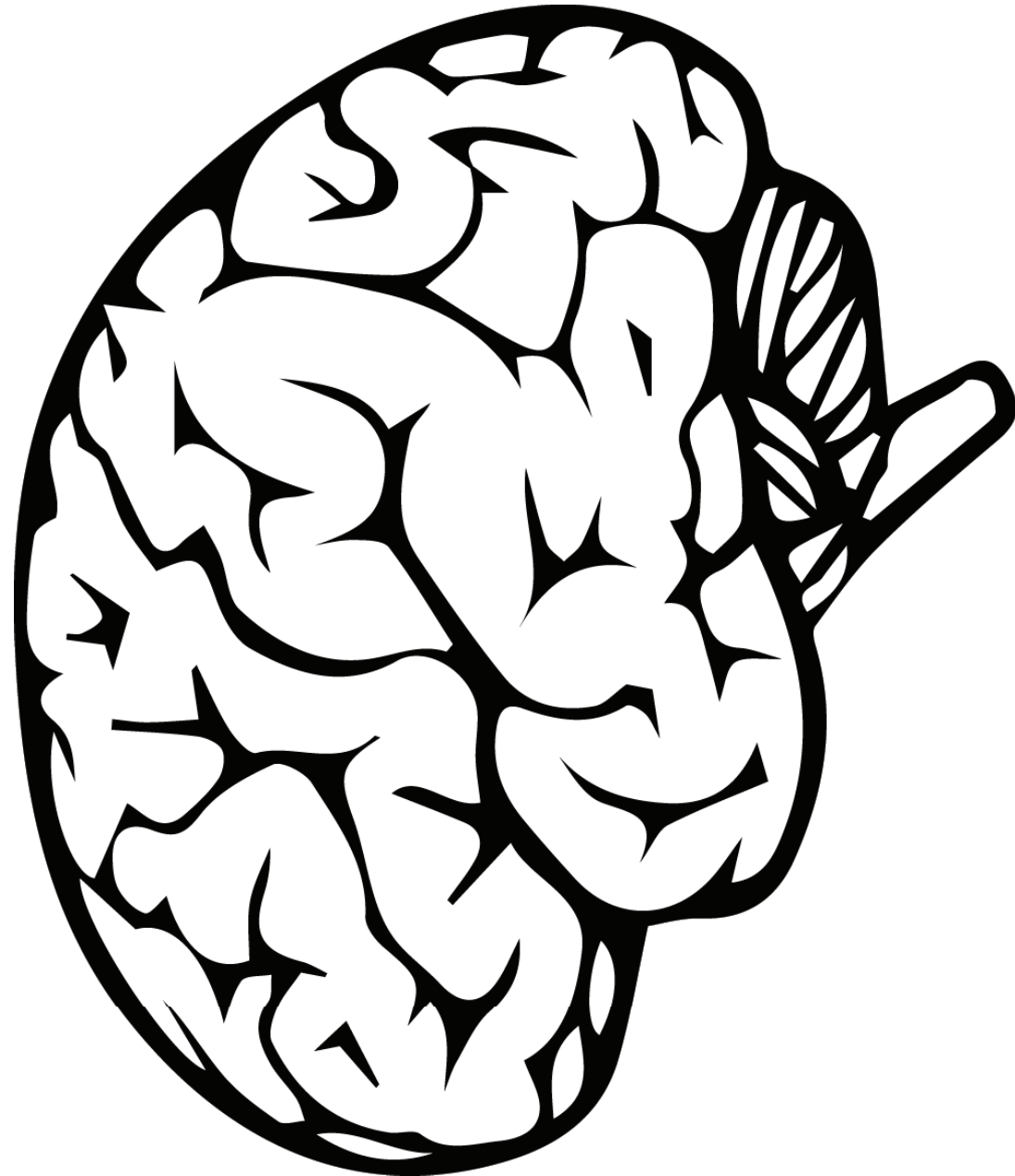

brain

whisper whisper

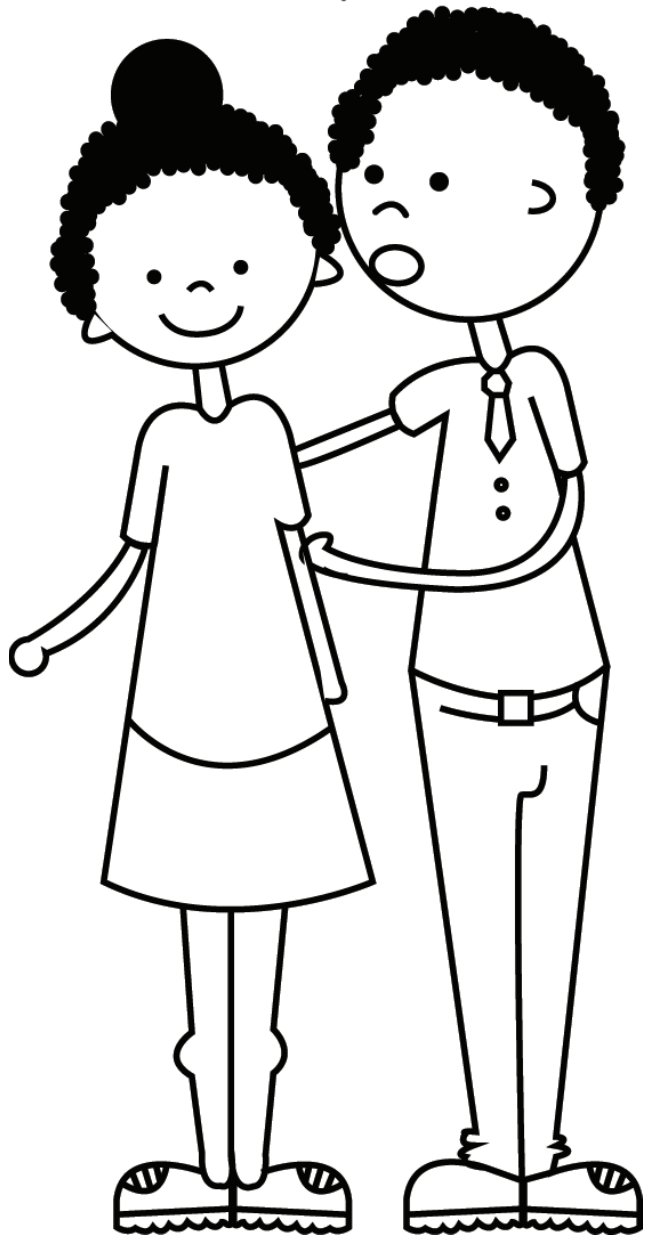

tell



secret

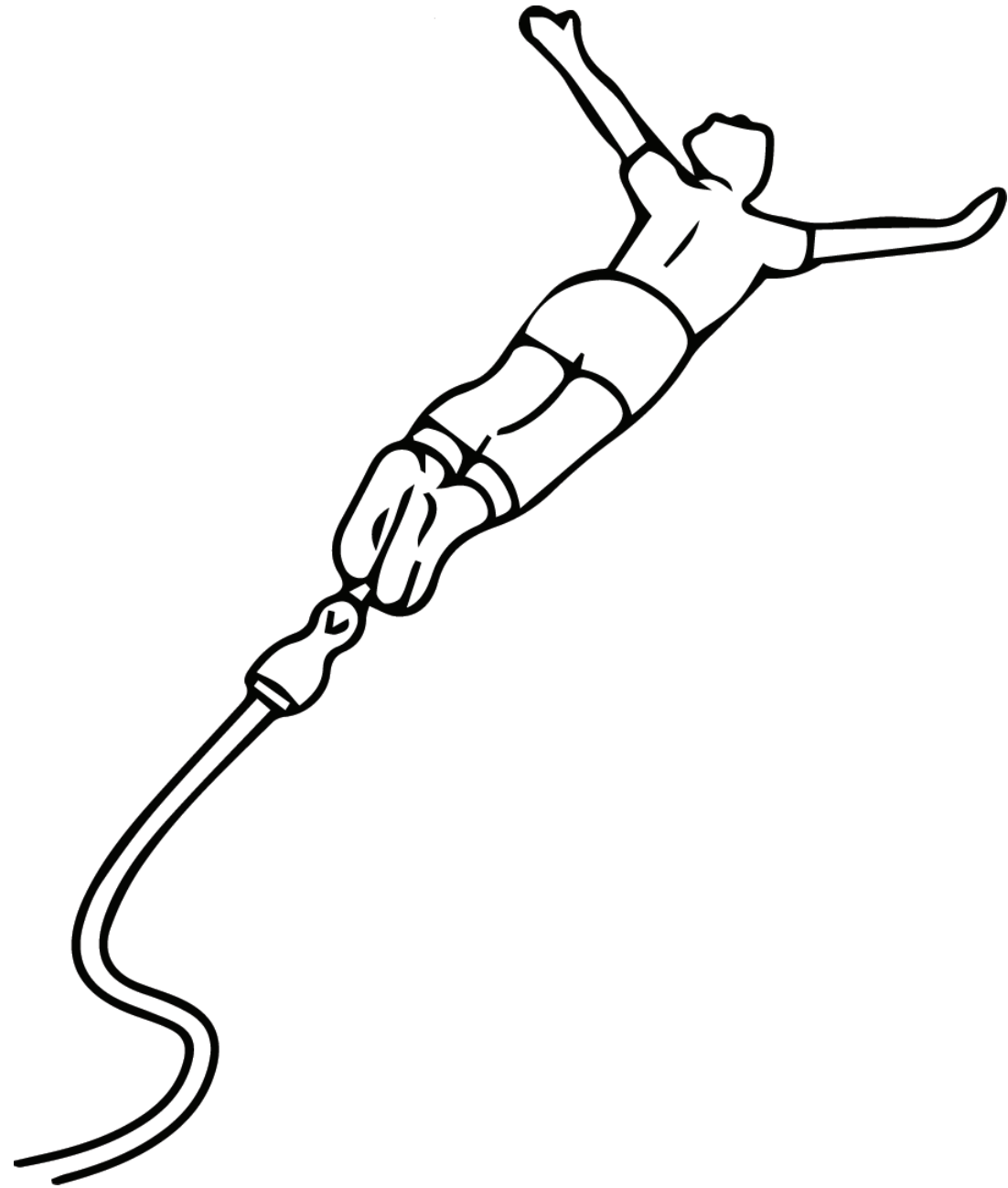

brave



trust

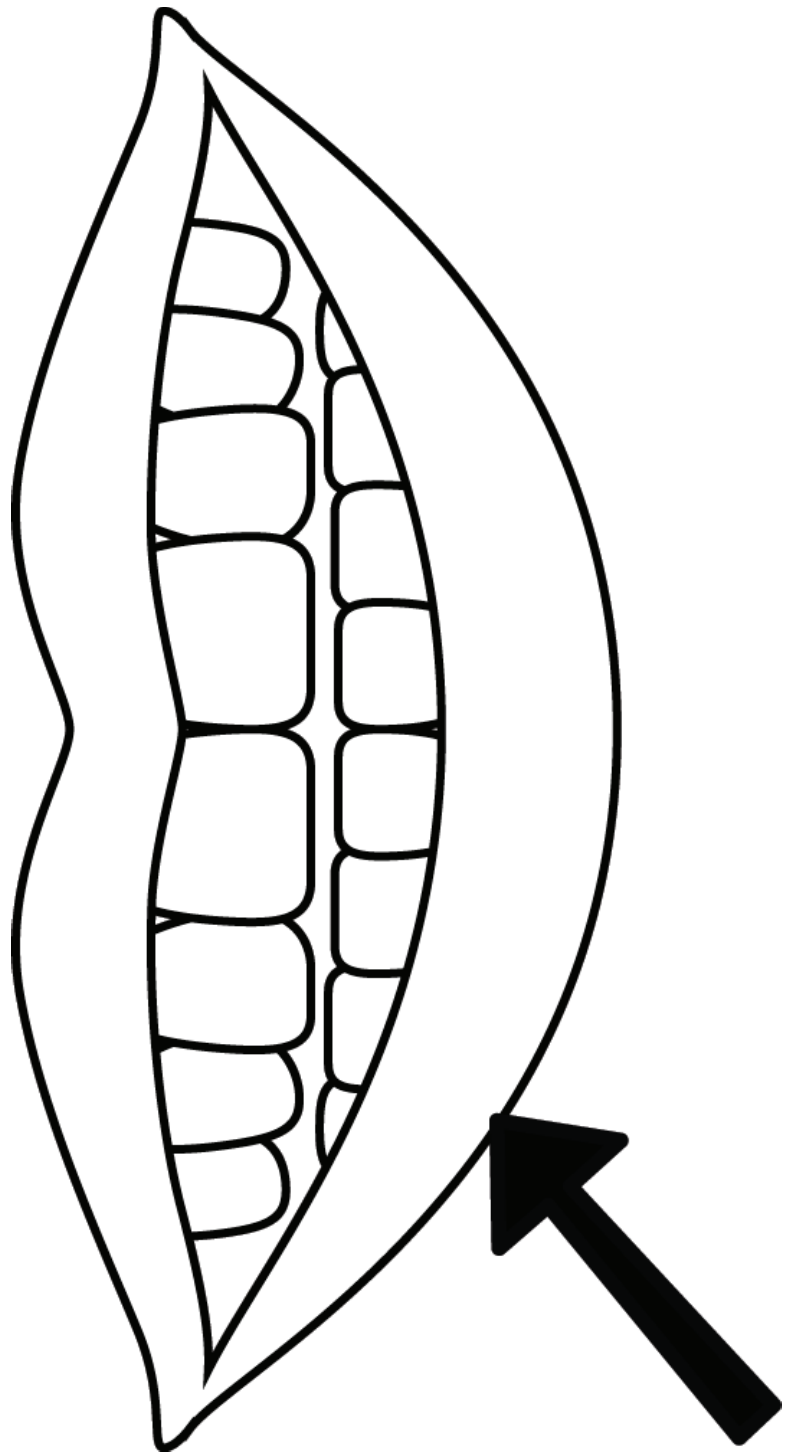

lips

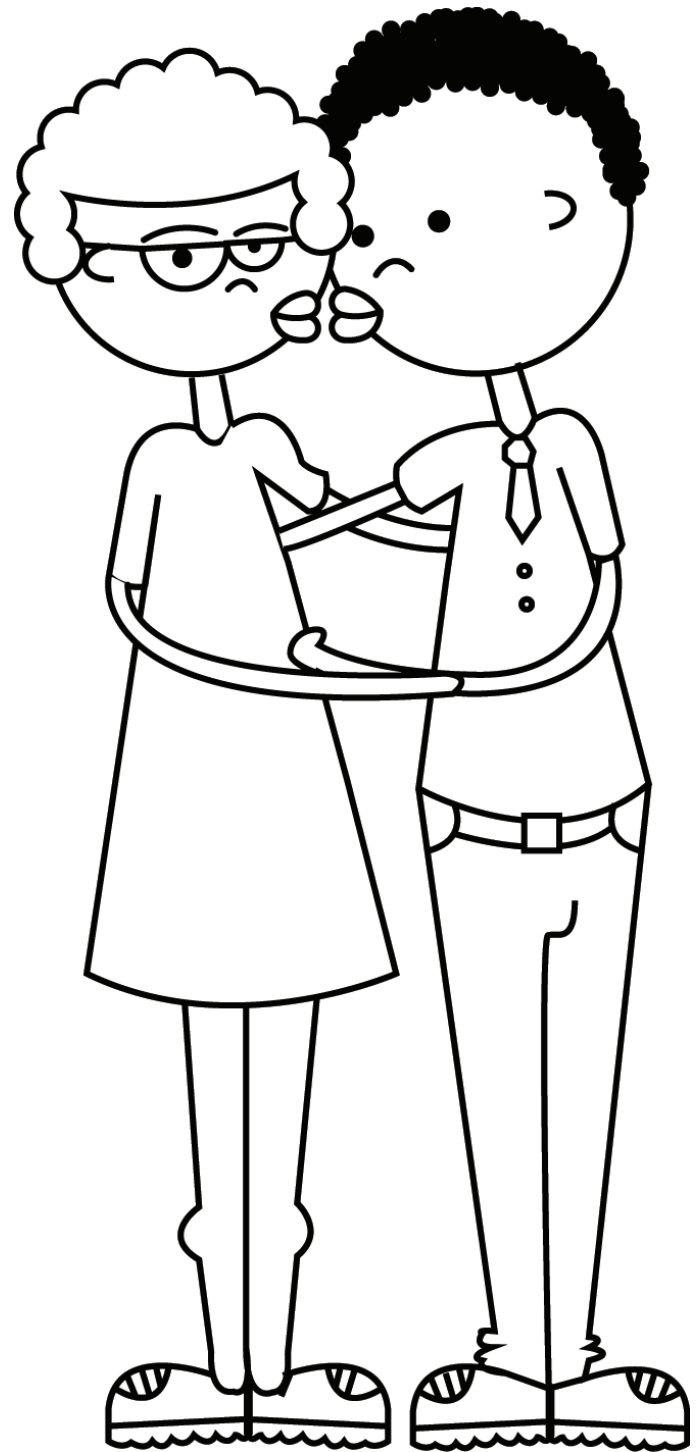

kiss